

LEROY[®]

**controlled lettering
equipment**

CATALOG 6



KEUFFEL & ESSER COMPANY

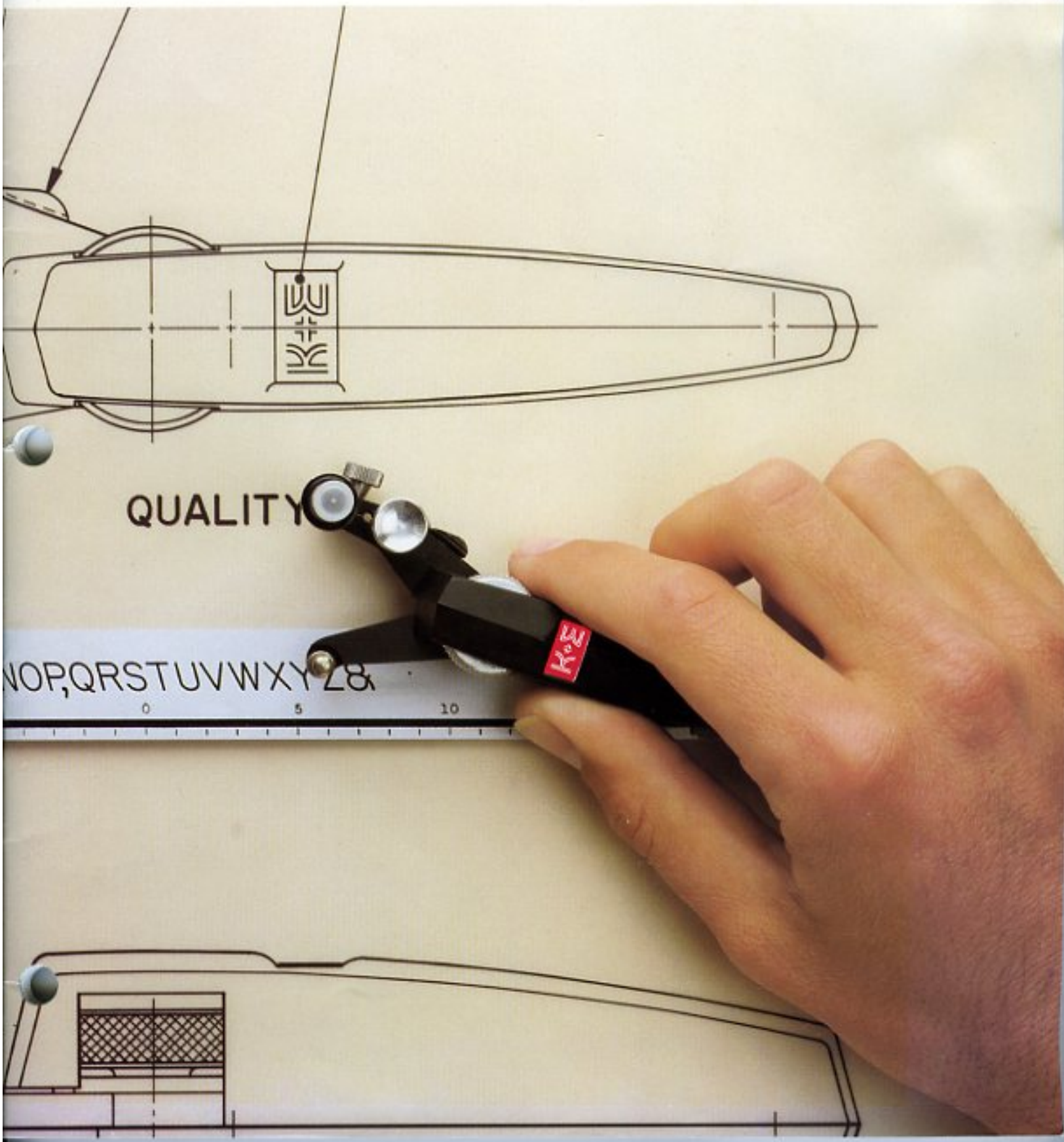



Catalog 6

Additional catalogs covering the K&E product line are available from the Keuffel & Esser Company, Morristown, N.J., or from the nearest K&E Branch or Dealer.

No.

- 1 Drafting Media
- 2b Photo Products
- 2c Diazo Products
- 3 STABILENE® Stable Base Materials
- 4 Graphic Charting and Digital Plotter Media
- 5 Drawing Instruments and Drafting Supplies
- 6 LEROY® Controlled Lettering Equipment
- 7 Drafting Machines and Drafting Room Furniture
- 9 Optical Alignment Equipment
- 10a Surveying Instruments
- 10b Electronic Distance Measuring Equipment
- 10c Electronic Surveying Systems
- 11 Field Equipment
- 12 Measuring Tapes

Established in 1867, K&E first published a catalog in 1868.

SPECIAL NOTICE

General Notice—Items sold by Keuffel & Esser Company are subject to discontinuance and price change without notice. All orders are subject to acceptance at the Company's General Office or a K&E Branch. Title passes to the Buyer upon delivery of goods to the Carrier.

Ownership of Goods in Transit—The Consignor's responsibility for delivery or damage of goods ceases when title passes to the Consignee, and, therefore, Consignor's responsibility ceases as soon as the goods are delivered to the Carrier. Thereafter, responsibility for non-delivery, damage, and payment for goods resides in the Consignee. Claims against the Carrier must be made by the Consignee within time limits specified by the Carrier. The fact that notice has been given to the Carrier that the goods have not been delivered and that a request has been made to trace them, does not serve to extend the period within which claims for damage or loss may be made. When requested, we will furnish the necessary documents for making these claims. Shipments will be made without declaration of value unless Customer requests otherwise. Parcel Post shipments are insured for invoice price only, unless Customer requests otherwise. The Customer will be charged for the cost of any insurance. All prices are FOB shipping point unless other terms are specifically agreed upon.

Limits of Liability—Goods purchased for personal, family or household purposes are sold by Keuffel & Esser Company WITHOUT ANY IMPLIED WARRANTIES OF MERCHANTABILITY OR FITNESS FOR USE and without any other warranties, expressed or implied.

Any other goods (except glass parts, lamps, fuses and the like) found by Keuffel & Esser Company to be defective in material or workmanship will be repaired or, at Keuffel & Esser Company's option, replaced for the original purchaser, provided the goods are returned,* transportation prepaid, within 90 days of original purchase to the K&E Branch or Dealer from which the goods were purchased, and in as good condition as when originally purchased, ordinary wear resulting from careful use only excepted, and the goods have not been subjected to movement or relocation after installation where installation is required, misuse, rough handling, alteration or servicing by other than an authorized service representative, negligence, fire, accident, water damage, Acts of God, or other casualty. The foregoing is in lieu of any expressed or implied warranties and THERE ARE NO IMPLIED WARRANTIES OF MERCHANTABILITY OR FITNESS FOR USE.

K&E assumes no responsibility for any inconvenience, loss, injury, or direct or consequential damage arising from the possession or use of the goods.

*Note: Arrangements for return of goods should be made in advance through the K&E Branch or Dealer from which the goods were purchased.

Contents Guide

See NUMERICAL INDEX on Pages 38-40

A	
Accessories	35-37
C	
Case without Contents	36
Cleaning Fluid for Pens	35
Cleaning Kits	35
Cleaning Pins for Standard Pens	29
Compass Adapter	37
Compass with Reservoir Pen Adapter	37
D	
Dry Seal Selector Sets	30, 31
E	
Empty Case	37
G	
Guide to Template and Pen Combinations	9
I	
Inks	35
L	
Lead Cleaners	36
Lead Clutch and Leads	36
Lead Pointer	36
Letter Size Adapter	36
LETTERING SETS	
Metric	32
Microfont	6
Standard	4, 5
Starter	6
Lettering Sizes (Template and Pen Combinations)	9
Long Point Pens	29
M	
Mechanical Pencil	36
Metric Standard Templates	33
Metric Standard Lettering Sets	32
Metric Professional Pens	34
Microfont Lettering Set	6
P	
Pencil, 0.5mm	36
Pencil Lead Cleaner	36
Pen Cleaners	35
Penholders	28, 29
PENS	
Metric Standard Professional	34
Reservoir	28
Standard	29
Standard Professional	30, 31
Pressure Pen Cleaner	35
Professional Pens—Metric	34
Professional Pens—Standard	30, 31
R	
Recommended Template & Pen Combinations	9
Replacement Points for Reservoir Pens	28
Reservoir Pens	28
S	
Scribers	7
Sets, Lettering	4-6
SLIDECOMP Compass	37
Standard Lettering Sets	4, 5
Standard Pens	29
Straightedge, Line Spacing	36
T	
TEMPLATES	
Bernhardt Modern Bold	18
Cartographic	17
Caslon Bold Condensed	18
Electrical Symbols	24
Electronic Tube Symbols	24
Europa	20
Fraction	25
Freehand	19
Geological Symbols	22
Gothic, Alternate	16
Gothic, Condensed	13
Gothic, Extended	14
Gothic, Franklin	15
Gothic, News	14
Gothic, News, Condensed	14
Gothic, News, Bold	14
Gothic, Outline	15
Gothic, Reversed	13
Gothic, Standard	12
Graph Symbols	27
Greek	20
Hebrew	21
Informal Style	19
Instrument Dial	20
Isometric	21
Isometric Circles	21
Map Symbols	22
Mathematical Symbols	25
Metric Standard	11, 12, 33
Microfont	21
Military Map Symbols	22
Modern	13
Music Symbols	25
Musicopy	26
Nitsche Bold	15
North Pointers	23
Old English	18
Outline Shadow	20
Russian	21
Script	19
Shadow	19
Slur-Tie	26
Spartan Black	16
Spartan Extra Black	17
Spartan Medium	16
Standard Lettering	9, 10, 12
Stymie Medium	17
"Your Own Design"	27
Tracer Pin	7
TRU-POINT, Lead Pointer	36
U	
Ultrasonic Cleaner	35

LEROY® Controlled Lettering Equipment

One of the draftsman's most useful tools is the lettering set, with which perfect lettering can be made easily and rapidly. Of all lettering equipment, the brand with the broadest scope is LEROY Lettering and Symbol Drawing Equipment.

LEROY is preferred because it is the lettering equipment that is most useful, highest in quality, and most efficient to use. LEROY gives you:

Utility — A great variety of lettering styles, alphabets, and symbols are available in a wide range of sizes and thicknesses.

Quality — LEROY products reflect proven K&E craftsmanship and quality of materials. LEROY Lettering and Symbol Drawing Equipment is precision engineered in every detail. And your LEROY equipment will give you years of steady service.

Convenience — Designed by K&E for utmost simplicity of operation, LEROY lettering needs no special skill or technique to produce perfect neatness and uniformity in the work.

LEROY Lettering is as simple as this...

You need only three basic items. This is how to use them.

- 1. LEROY Template** — Choose the template with the size and style of lettering you want. (There are many styles and sizes of alphabets, as well as graphical symbols. Also, templates can be made specially for you to your own design.) Lay it along your straightedge.
- 2. LEROY Pen or Pencil**
LEROY Pen — Choose the type of pen (Reservoir or Standard) with the width that best suits the job you are doing. Set the pen in the socket in the upper arm of the scribe.
LEROY Pencil — For pencil lettering work, you can use either the LEROY 0.5mm Pencil or the LEROY Lead Clutch that holds any regular draftsman's lead. Both work with all LEROY scribes.
- 3. LEROY Scriber** — Set the tail pin of the scriber in the straight guide groove of the template. With the tracer pin of the scriber simply trace the engraved letters on the template. The pen reproduces the letter or symbol in full view, above the template.

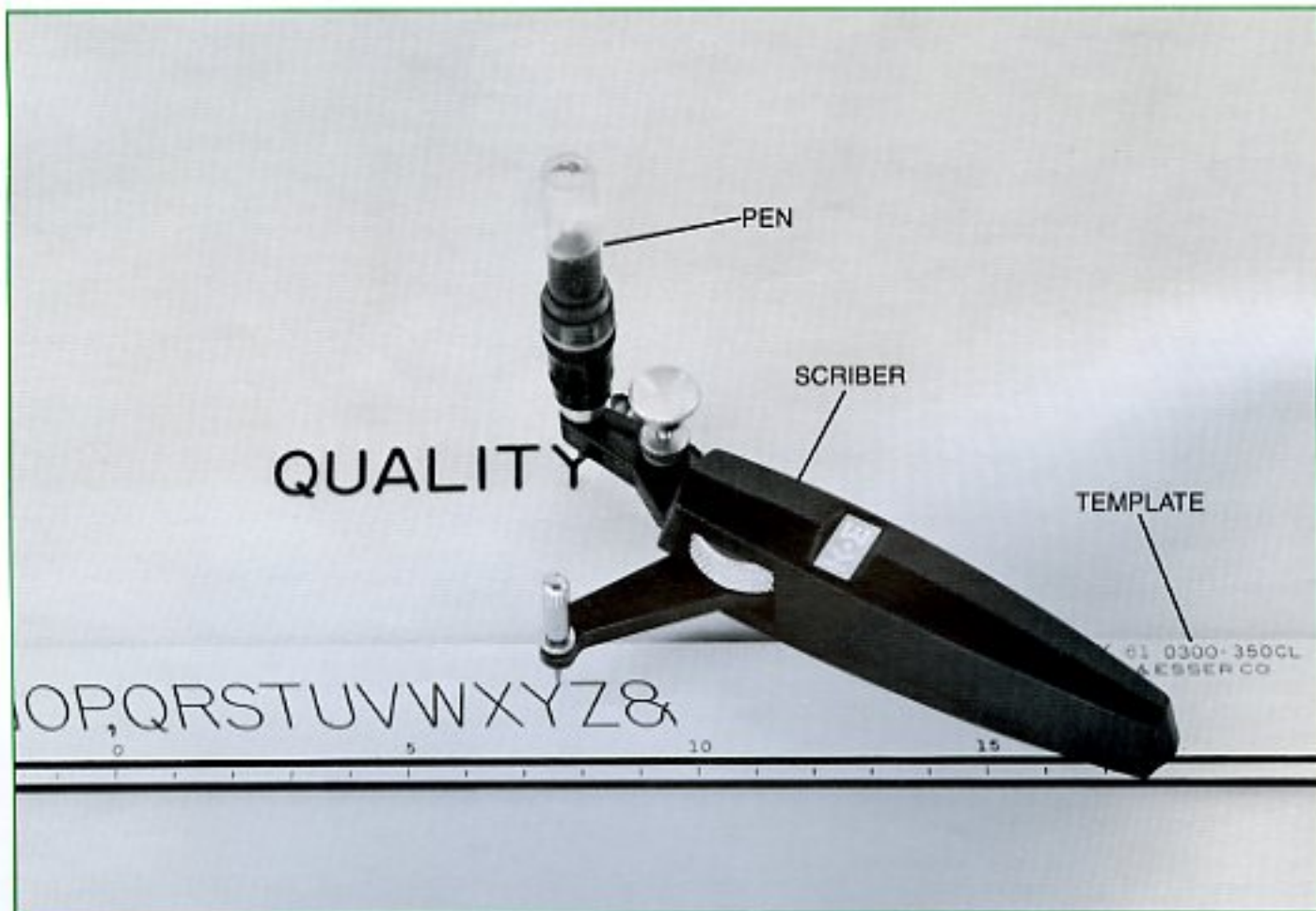

LEROY[®]

Templates AND PENS

& SCRIBERS **make**

Letters OF MANY STYLES

numbers **1,2** AND SYMBOLS

 **even** music 

SPECIAL DESIGNS **K** \neq Σ 

AND SIGN *your* name...

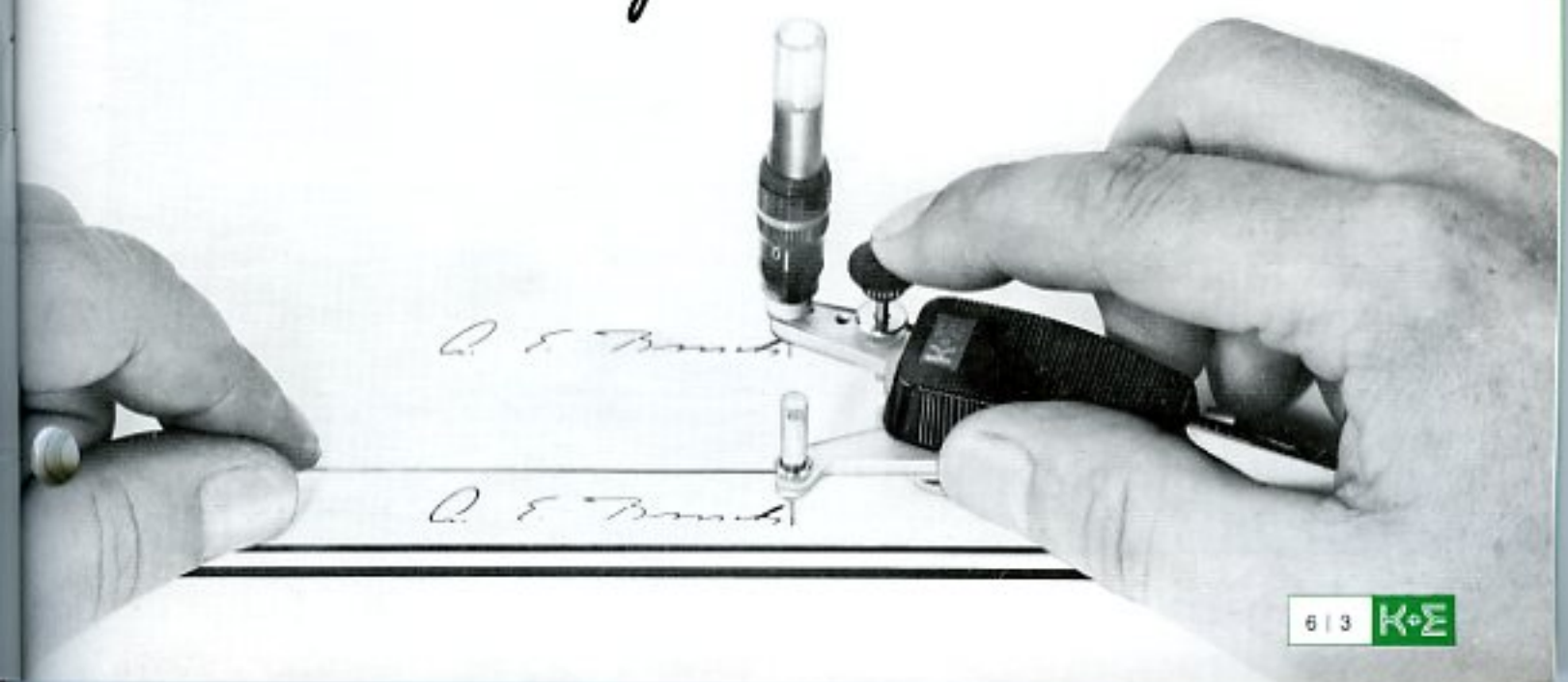

LEROY® Standard Lettering Sets



A new, attractive two-tone green case protects LEROY Lettering Sets in high-impact, molded plastic. The case features a new contemporary design with a removable lid for easier handling and greater efficiency; when the cover is removed, the base of the set becomes a convenient work tray—ideal for use from desk drawers or any work surface. Inside lid is foam covered to keep all items securely in place. The case resists moisture, warping and dust.

Features of LEROY Sets

- Bottom of tray is sectioned to conveniently hold items in minimum space.
- Removable pen block for holding eleven standard pens.
- New, improved scriber for easy, precision lettering.
- Pen holder for using Reservoir Pens with straightedges, curves, etc.
- Pen storage for eight Reservoir Pens.
- Slanted template storage for easy selection at a glance.

When cover is removed base of set can be used as work tray

To remove cover:
1. Raise cover to the fully open 90° position.

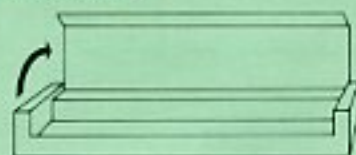

2. Grasp set at sides and place thumbs in bottom corners of cover. Exert sufficient pressure until cover slides to rear and is clear of case.



To replace cover:
Insert edge of cover into slot at rear of case and push until entirely seated.



STANDARD LETTERING SETS WITH CAPITAL AND LOWER CASE LETTERS AND NUMERALS

All sets contain 61 0003 Adjustable Scriber, 61 0200 0.5mm Pencil with leads, 61 0055 Reservoir Pen Holder, 61 3075 Standard Pen Holder, 58 0005 Ink Cartridge.

The five sets listed below are furnished in the same basic size plastic case. The smaller sets have empty spaces for additional pens and templates.

See chart below. A mark under the set number indicates that one each of the listed template and pen is included in the set.

61 2901 LEROY Set — 11 templates, 11 standard pens, 7 reservoir pens.

61 2906 LEROY Set — 8 templates, 10 standard pens, 7 reservoir pens.

61 2911 LEROY Set — 5 templates, 5 standard pens, 5 reservoir pens.

61 2916 LEROY Set — 6 templates, 6 standard pens, 6 reservoir pens.

61 2921 LEROY Set — 3 templates, 3 standard pens, 2 reservoir pens.

Product No.	Set No. 61 2901	Set No. 61 2906	Set No. 61 2911	Set No. 61 2916	Set No. 61 2921
Templates					
61 0300 - 80CL	•				
100CL	•	•		•	•
120CL	•	•		•	
140CL	•	•	•	•	•
175CL	•	•	•	•	
200CL	•	•		•	
240CL	•	•	•	•	•
290CL	•				
350CL	•	•	•		
425CL	•				
500CL	•	•	•		
Standard Pens					
61 0070 - 000	•				
00	•	•		•	•
0	•	•		•	
1	•	•	•	•	•
2	•	•	•	•	
3	•	•	•	•	•
4	•	•	•	•	
5	•	•			
6	•	•	•		
7	•	•			
8	•	•			
Reservoir Pens					
61 0051 - 00	•	•		•	•
0	•	•		•	
1	•	•	•	•	•
2	•	•	•	•	
3	•	•	•	•	
4	•	•	•	•	
5	•	•	•		

See page 32 for Metric Sets.

Basic contents of LEROY Lettering Sets



61 0003



61 0200



61 0055



61 3075



58 0005

LEROY® Lettering Sets

METRIC STANDARD LETTERING SET

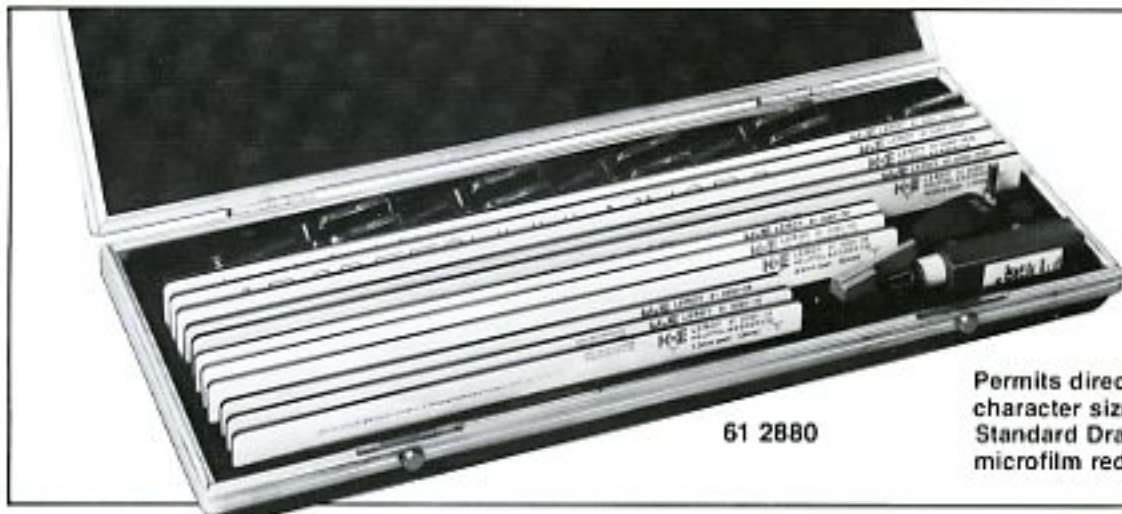

61 2880

Permits direct correlation of character sizes and line widths to Standard Drawing Sizes and microfilm reductions/blowbacks.

61 2880 LEROY Metric Standard Lettering Set—Contains a complete set of 9 Metric Technical Pens and 9 matching Metric Standard Templates (11 template sections); one Adjustable Scriber 61 0004; one ¼ oz. bottle of LEROY® Ink 58 0006; and 2 nib keys. In formed plastic case.

61 2890 LEROY Metric Standard Lettering Set—Contains 4 Metric Technical Pens in point sizes 0.25mm, 0.35mm, 0.50mm and 0.70mm; 4 Metric Standard Templates in capital letter sizes 2.5mm, 3.5mm, 5.0mm and 7.0mm; one Adjustable Scriber 61 0004; one ¼ oz. bottle LEROY Ink 58 0006; and 2 nib keys. In formed plastic case. For complete description, see page 32.

MICROFONT SET

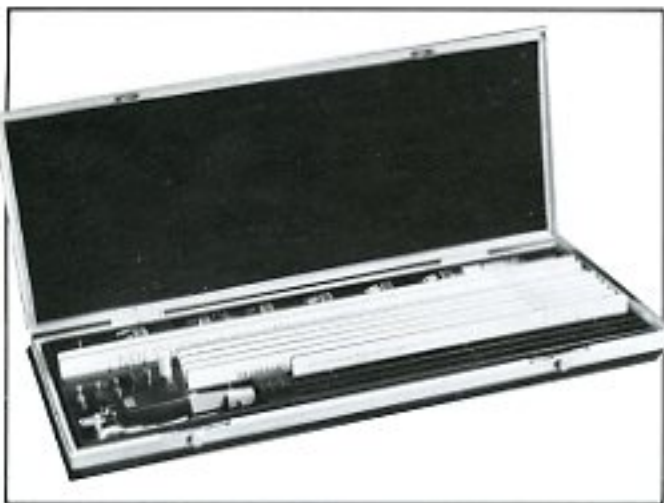

61 2942 LEROY Microfont Set—Microfont is a special lettering style capable of maintaining maximum clarity and legibility at extreme reduction and enlargement ratios.

The set has a protective case made of tough formed plastic, metal reinforced. A one-piece removable tray holds contents in minimum space. The set contains 8 Microfont Lettering Templates (see page 21), 6 reservoir pens, 6 standard pens (sizes 0, 1, 2, 3, 4, 5), Adjustable Scriber 61 0004, and basic contents as listed for the Standard Sets on page 5.

STARTER SET



61 2944 LEROY Starter Set— Contains the basic components needed to get started with controlled lettering without having to make a major investment.

Packaged in a convenient two-piece slide-pak, the set contains:

- 1 Adjustable Scriber No. 61 0003
- 2 Lettering Templates Nos. 61 0300-100CL, -140CL
- 2 Standard Lettering Pens Nos. 61 0070-00, -1
- 1 Reservoir Pen No. 61 0051-00
- 1 Reservoir Pen Holder No. 61 0055
- 1 Pencil Lead Clutch No. 61 0210
- 1 Ink Cartridge No. 58 0005
- 1 Template Positioning Guide

LEROY® Scribers

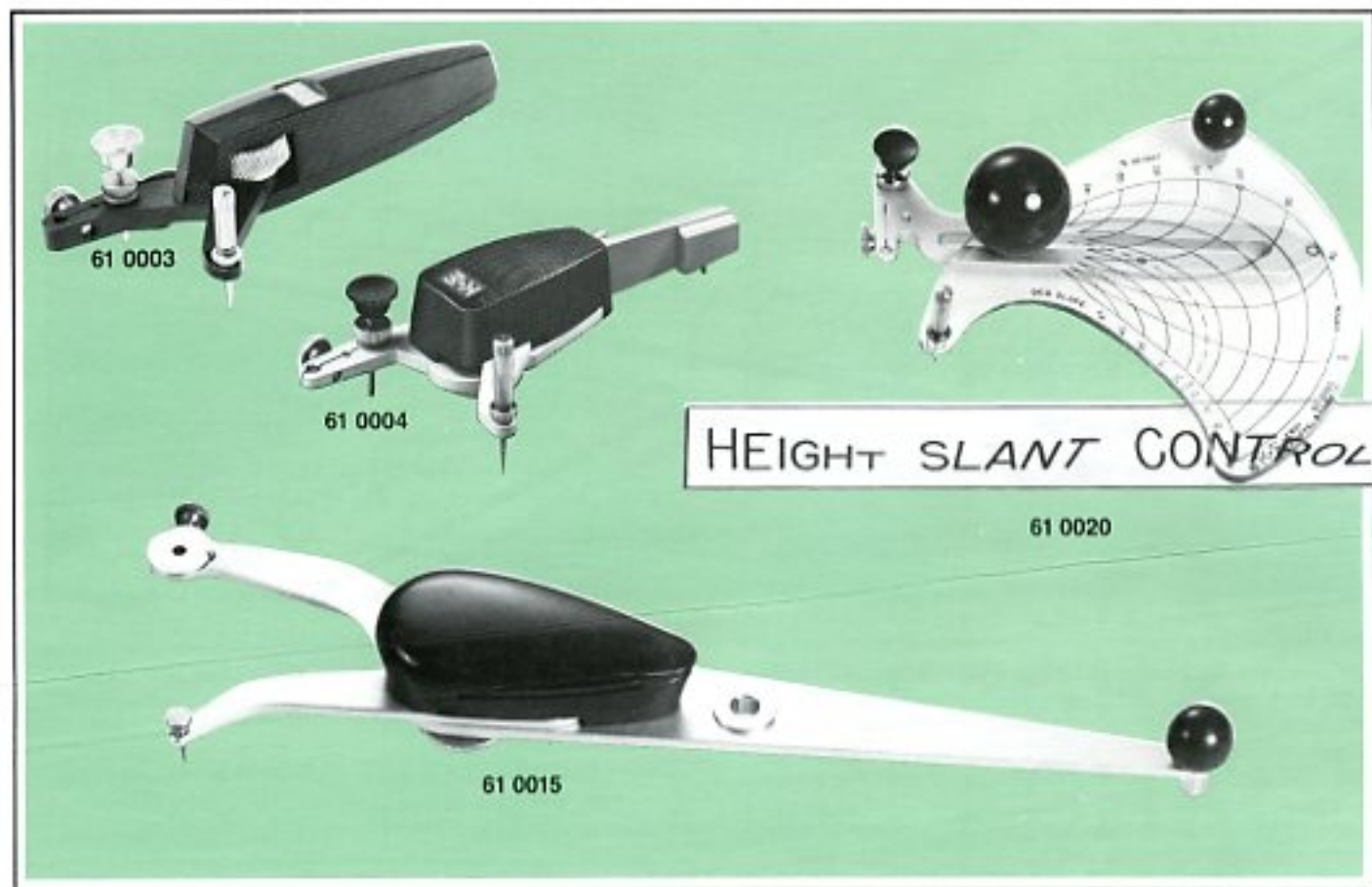

DESIGN—LEROY Scribers are precise instruments, handsome and streamlined in design, easy to handle. Precision-manufactured from high strength materials, they are light in weight and engineered for effortless lettering.

CONSISTENT ACCURACY—The unvarying relationship of its three main elements, the tracer pin, the pen, and the tail pin, assures the unvarying consistency of the lettering on the drawing.

BALANCE—LEROY Scribers are perfectly balanced. They are easy to operate. The tracer pin glides smoothly through the engraved characters on the template, and requires no pressure. The weighted tail piece holds the tail pin in the horizontal groove of the template as the tracer pin is moved from letter to letter.

61 0003 Adjustable Scriber—Completely new modern design with improved functions for ease in operating. Features include; improved thumb nut for easy adjustment of tracer arm for vertical and slant lettering; new 15° slant setting that is the maximum recommended slant by ISO Standards; kick stand designed for one-hand operation holds pen point off surface when not in use; and new clamping action of side thumb screw holds pen securely with minimum effort. For use with all LEROY Pens up to size 8, all sizes of metric pens, and all LEROY Pencils and

with all LEROY Templates up to size 650 and 60 point. Furnished with Double Ended tracer pin.

61 0004 Adjustable Scriber — For use with all LEROY Pens up to size 8 and LEROY Pencils; and with all LEROY Templates up to size 650. Pens are held by side thumb screw. Adjustable tracer arm for both vertical or slant lettering. Furnished with Double-Ended Tracer Pin.

61 0015 Adjustable Scriber — For use with LEROY Templates size 700 and larger, and Templates 72 point and larger, for vertical or slanting lettering. Adapters furnished for use with Pens 0000 to 8, and 9 to 14.

61 0020 Height and Slant Control Scriber — Adjustable to form characters either vertical or slanting at any angle up to 45° forward, and any height from 60% to 150% of the size of the characters on the template used. The width of the characters is not changed. Adjustment is simple, by loosening the knob, moving the arm so that the small red circle on the arm lies directly under the intersection of the "degree slope" and "% height" lines desired. Knob is then re-tightened. Takes pens 0000 to 8. Can be used with LEROY Lettering Templates up to size 500C. Furnished with Double Ended Tracer Pin.

61 3010 Double-Ended Tracer Pin — For use with regular and fine groove LEROY Templates. Fits all LEROY Scribers.

LEROY® Lettering Templates

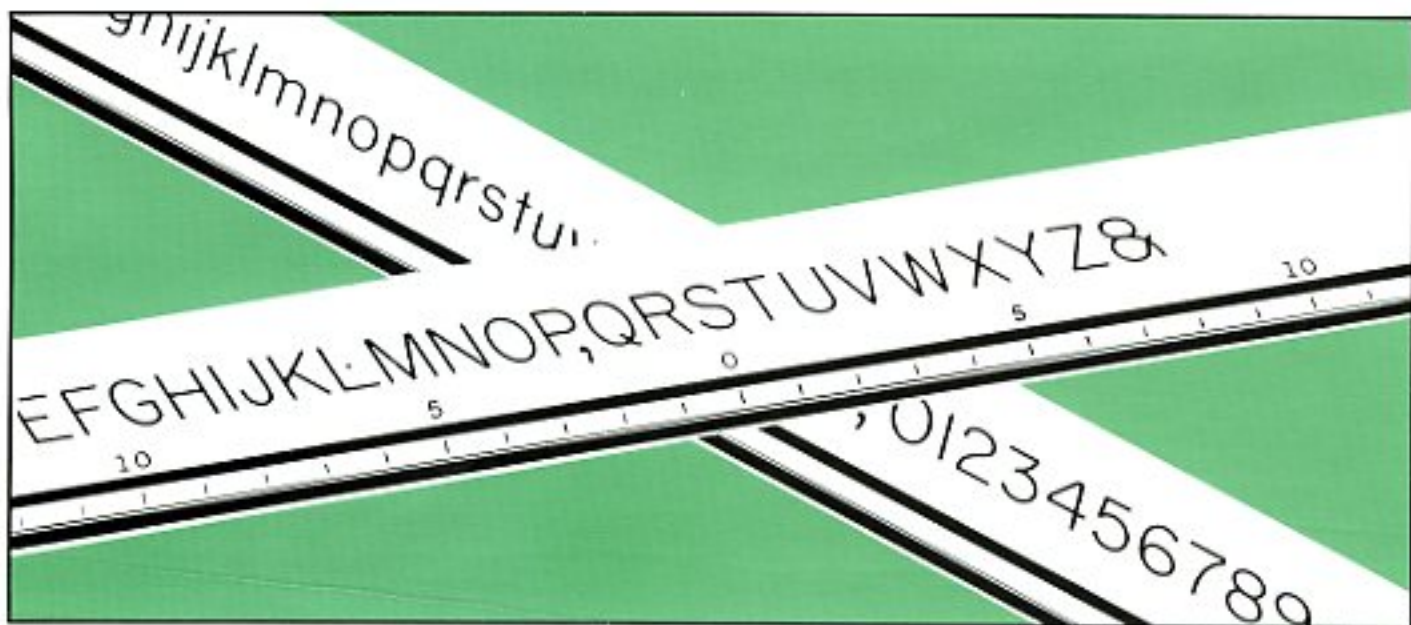

CONSTRUCTION

LEROY templates are made of twelve layers of special plastic material, thick and heavy enough to resist warping and distortion. The outside layers are white and the middle layer black, permanently laminated together for extra strength and stability. The characters are engraved right through the outer white layer to the black middle layer. They stand out in sharp permanent black-on-white contrast. Each letter, number, and symbol is engraved complete and can be drawn complete without shifting the template.

UNIFORM BASELINES

You can change LEROY templates from one size of letter to another, or turn the template over for the characters on the back and continue the same line of lettering, without having to move your straightedge. This is so because the distance from the bottom of the letters to the lower edge of the template is uniform throughout all standard and nearly all other LEROY lettering templates.

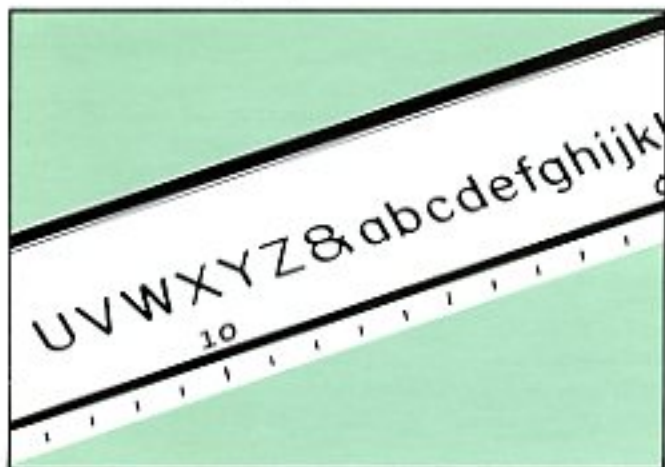

CAPS, LOWER CASE, AND NUMBERS COMBINED

LEROY templates combine capitals, lower case and numbers, all complete on one template. You do not have to buy these separately.

COMPLETE LETTERS AND NUMBERS

No partially formed letters or numbers. No shifting of the template to complete them.



NO "EXTRAS" NEEDED

Each LEROY template has a groove on either side in which the "anchoring" tail pin of the scribe rides. No extra straightedge is needed for this.

GREAT VARIETY

LEROY templates are available in a wide variety of styles and sizes of lettering, as well as in a range of graphical symbols which are an invaluable aid in neat, consistent symbol drawing.

EASY LETTER SPACING

Since the scale has a central zero on the lower edge of the template, you can quickly center or space any line of lettering.

LEROY® Standard Lettering Templates

RECOMMENDED TEMPLATE & PEN COMBINATIONS IN ACTUAL SIZE

The chart shows the wide range of LEROY lettering effects that can be produced by combining various LEROY templates and pens.

*Indicates the combination of template and pen recommended for a good proportion between the thickness of stroke and the size of letter.

TEMPLATE SIZE	PEN SIZE											
	0000	000	00	0	1	2	3	4	5	6	7	8
50	A*											
60	A*	A	B	C								
80	A	A*	B	C								
100		A	A*	B	C	D						
120		A	B	C*	D	E						
140		A	B	C	D*	E	F					
175		A	B	C	D	E*	F	G				
200		A	B	C	D	E	F*	G	H			
240		A	B	C	D	E	F*	G	H			
290			B	C	D	E	F	G*	H	K		
350			B	C	D	E	F	G*	H	K		
425			B	C	D	E	F	G	H	K	L	
500			B	C	D	E	F	G	H	K	L	M

All lettering shown actual size

A FASTER, BETTER WAY TO LETTER ENGINEERING DRAWINGS IS LEROY #012
 ABCDEFGHIJKLMNOPQRSTUVWXYZ abcdefghijklmnopqrstuvwxyz 01234
 Templates 50CL Pen 0000

A FASTER, BETTER WAY TO LETTER ENGINEERING DRAWINGS. opqrstuvwxyz
 ABCDEFGHIJKLMNOPQRSTUVWXYZ abcdefghijklmnopqrstuvwxyz, (%)#0123456
 Templates 60CL Pen 0000

A FASTER, BETTER WAY TO LETTER engineering drawings
 ABCDEFGHIJKLMNOPQRSTUVWXYZ abcdefghijklmnopqrst
 Templates 80CL Pen 000

A FASTER, BETTER WAY TO LETTER (%),#01
 ENGINEERING DRAWINGS, IS LEROY (%),#01
 abcdefghijklmnopqrstuvwxyz abcdefghijklmnop
 Templates 100CL Pen 00

A FASTER, BETTER WAY TO LETTER 012
 ENGINEERING DRAWINGS IS LEROY #012
 a faster, better way to letter engineering dr
 Templates 120CL Pen 0

A FASTER, BETTER WAY TO (%),#012
 LETTER ENGINEERING DR (%),#012
 drawings is Leroy a faster, better
 Templates 140CL Pen 1

A FASTER, BETTER (%),#01234
 WAY TO LETTER ENGINEERIN
 drawings is Leroy a faster, be
 Templates 175CL Pen 2

LEROY® Standard Lettering Templates

A FASTER, BETTER 1234
WAY TO LETTER ENGINEERING
drawings is Leroy *a faster,*

Templates 200CL Pen 3

A FASTER, BETTER 34
WAY TO LETTER (%) ,
engineering *drawing*

Templates 240CL Pen 3

A FASTER 12 *BETT*
way to letter *engin*

Templates 290CL Pen 4

A FAST 4 *BET*
a faster, *better*

Templates 350CL Pen 4

A FAS 78 *BE*
way to letter *e*

Templates 425CL Pen 5

A FAS 12 *B*
way to *letter*

Templates 500CL Pen 6

DES ab

Templates 700C & 700L Pen 8

CDhol

Templates 1000C & 1000L Pen 10

REin

Templates 1350C & 1350L Pen 12

PA

Template 2000C Pen 14



LEROY[®] Metric Standard Lettering Templates

Letters and line width shown actual size

LEROY METRIC CONFORMS TO ISO STANDARD 3098/1 (%), = 0, 0
 abcdefghijklmnopqrstuvwxyz, 0123456789
 ABCDEFGHIJKLMNOPQRSTUVWXYZ abcdefghijklmnopqrstuvwxyz, (%)
 Template 13 Pen .13

LEROY METRIC CONFORMS TO ISO STANDARD , =
 abcdefghijklmnopqrstuvwxyz, (%) 0123456789
 ABCDEFGHIJKLMNOPQRSTUVWXYZ abcdefghijklmnopqrst
 Template 18 Pen .18

LEROY METRIC CONFORMS TO ISO (%),
 abcdefghijklmnopqrstuvwxyz, = 0123456789
 ABCDEFGHIJKLMNOPQRSTUVWXYZ abcdef
 Template 25 Pen .25

LEROY METRIC CONFORMS 789
 TO ISO STANDARD 3098/1 (%),
 abcdefghijklmnopqrstuvwxyz, standar
 Template 35 Pen .35

LEROY METRIC CO 123
 CONFORMS (%), 0123 67
 abcdefghijklmn, pqrstuvwxyz
 Template 50 Pen .50

LEROY *METRIC 23*
 standard, (%) iso, 567

Template 70 Pen .70

LEROY 12 M 7
 metric standa=

Template 100 Pen 1.00

LER 89 T/
 metric stan

Templates 140C & 140L Pen 1.40

RS UV c

Templates 200C & 200L Pen 2.00

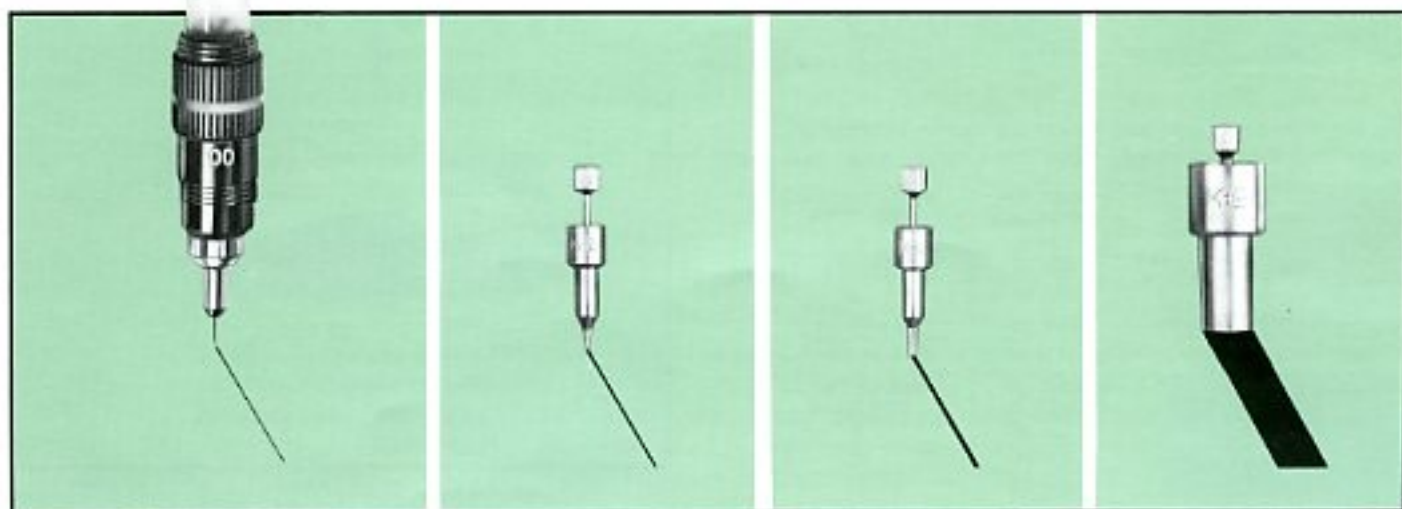

LEROY® Lettering Templates

STANDARD TEMPLATES

These templates form both vertical and slanting letters when used with Adjustable Scribers 61 0003 and 61 0004. The height and slant of letters can also be changed by using these templates with Scriber 61 0020 (see page 7). Standard lettering templates are furnished with LEROY Lettering Sets (see chart, page 5).

,ABCDEFGHIJKLMNOR,
 QRSTUVWXYZ&
 (%)#0123456789.
 abcdefghijklmnop
 qrstuvwxyz

Actual size of 61 0300-240CL

CAPITAL AND LOWER CASE LETTERS AND NUMBERS	HEIGHT OF CAPITALS	RECOMMENDED PEN SIZES
61 0300-50CL*	0.050 in.	0000
-60CL*	0.060 in.	0000
-80CL*	0.080 in.	000
-100CL	0.100 in.	00
-120CL	0.120 in.	0
-140CL	0.140 in.	1
-175CL	0.175 in.	2
-200CL	0.200 in.	3
-240CL	0.240 in.	3
-290CL	0.290 in.	4
-350CL	0.350 in.	4
-425CL	0.425 in.	5
-500CL	0.500 in.	6

The templates below form both vertical and slanting letters when used with Adjustable Scriber 61 0015.

CAPITAL LETTERS AND NUMBERS	HEIGHT OF CAPITALS	RECOMMENDED PEN SIZES
61 0350-700C	0.700 in.	8
-1000C	1.000 in.	10
-1350C	1.350 in.	12
-2000C†	2.000 in.	14

LOWER CASE LETTERS	HEIGHT OF CAPITALS	RECOMMENDED PEN SIZES
61 0400-700L	0.700 in.	8
-1000L	1.000 in.	10
-1350L	1.350 in.	12

METRIC STANDARD TEMPLATES

The templates listed below conform to the dimensional characteristics set forth in International Standard ISO 3098:1 for technical drawings and lettering. When used with Scribers 61 0003 and 61 0004, both vertical and slant letters can be formed. These templates are same as furnished with LEROY Metric Standard Lettering Sets (see page 32).

CAPITAL AND LOWER CASE LETTERS AND NUMBERS	HEIGHT OF CAPITALS	RECOMMENDED PEN SIZES
61 0260-13CL	1.3mm	13
-18CL	1.8mm	18
-25CL	2.5mm	25
-35CL	3.5mm	35
-50CL	5.0mm	50
-70CL	7.0mm	70
-100CL	10.0mm	100
-140C	14.0mm	140
-140L	14.0mm	140
-200C	20.0mm	200
-200L	20.0mm	200

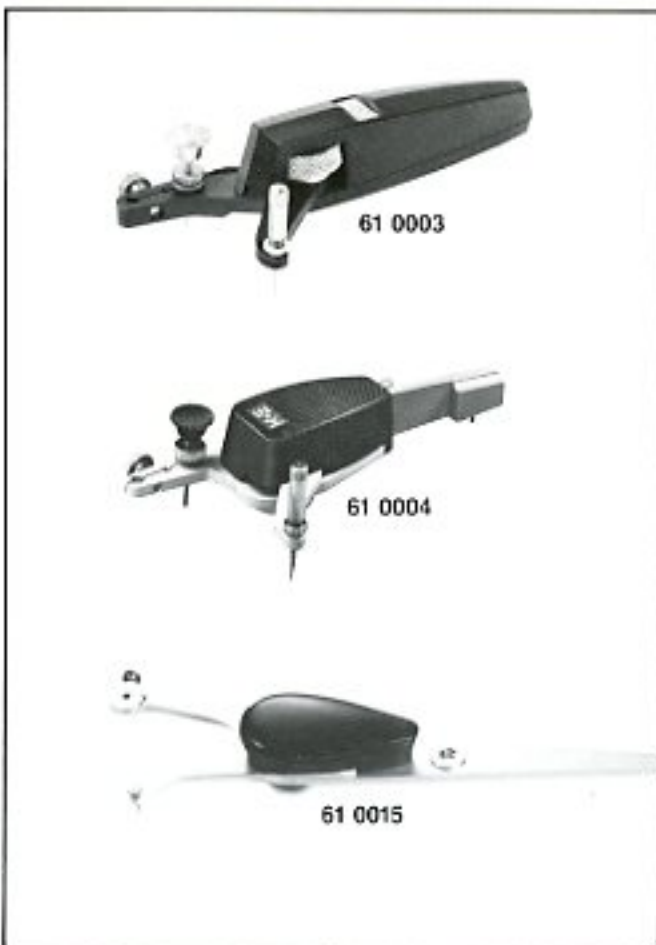

*Use only with Fine Groove Tracer Pen. †This template consists of two sections.

MODERN

ABCDEFGHIJKLMNOPQRSTUVWXYZ&!?"'*,*
abcdefghijklmnopqrstuvwxyz,;=x#:0123456789\$¢%.

Actual size of 61 0500-240CL

61 0450 Modern Templates-Capital letters and numbers.

Template sizes-	60C*	80C*	100C*	120C*	160C	200C	240C	320C	400C	480C
Pen sizes-	0000	000	00	0	1	2	3	4	5	6

61 0500 Modern Templates-Capital and lower case letters and numbers.

Template sizes-	60CL*	80CL*	100CL*	120CL*	160CL	200CL	240CL	320CL	400CL	480CL
Pen sizes-	0000	000	00	0	1	2	3	4	5	6

REVERSED GOTHIC

ABCDEFGHIJKLMNOPQRSTUVWXYZ&
ZYXWVUTSRQPONMLKJIHGFEDCBA,
(%)#0123456789

Actual size of 61 0550-240C

61 0550 Reversed Gothic Templates-Capital letters and numbers in same sizes as Standard LEROY Lettering. Recommended for lettering on the back of tracings, on photographic negatives or wherever reversed writing is required.

Template sizes-	80C*	100C	120C	140C	175C	200C	240C	290C	350C	425C	500C
Pen sizes-	000	00	0	1	2	3	3	4	4	5	6

CONDENSED GOTHIC

ABCDEFGHIJKLMNOPQRSTUVWXYZ &
(%)#0123456789

Actual size of 61 0600-240C

61 0600 Condensed Gothic Templates-Capital letters and numbers. Average width of lettering is about 3/5 that of standard LEROY Lettering.

Template sizes-	80C*	100C*	120C*	140C*	175C*	200C	240C	290C	350C	425C	500C	700C†	1000C†	1350C†	2000C†
Pen sizes-	0000	0000	000	00	0	1	1	2	2	3	4	7	8	10	12

abcdefghijklmnopqrstuvwxyz

Actual size of 61 0602-240L

61 0602 Condensed Gothic Templates-Lower case letters. Average width of lettering is about 3/5 that of standard LEROY Lettering. Not available in size 2000.

Template sizes-	80L*	100L*	120L*	140L*	175L*	200L	240L	290L	350L	425L	500L
Pen sizes-	0000	0000	000	00	0	1	1	2	2	3	4

*Use only with Fine Groove Tracer Pen. †Use with Scriber 61 0015.

LEROY® Lettering Templates

EXTENDED GOTHIC

A B C D E F G H I J K L M N O P Q R S T U
V W X Y Z (%) ' ! = 0 1 2 3 4 5 6 7 8 9

Actual size of 61 0650-240C

61 0650 Extended Gothic Templates—Capital letters and numbers. Average width of lettering is about 1 1/2 times that of Standard LEROY Lettering.

Template sizes—	80C*	100C	120C	140C	175C	200C	240C	290C	350C	425C	500C
Pen sizes—	00	0	1	2	3	4	4	5	5	6	7

NEWS GOTHIC

A B C D E F G H I J K L M N O P Q R S T U V W X Y Z
0 1 2 3 4 5 6 7 8 9

Actual size of 61 0660-240C

61 0660 News Gothic Templates—Capital letters and numbers.

Template sizes—	80C*	100C	120C	140C	175C	200C	240C	290C	350C*	425C*	500C	700C:	1000C:	1350C:
Pen sizes—	000	00	0	1	2	3	3	4	4	5	6	9	10	12

NEWS GOTHIC CONDENSED

A B C D E F G H I J K L M N O P Q R S T U V W X Y Z &
0 1 2 3 4 5 6 7 8 9 \$

Actual size of 61 0670-240C

61 0670 News Gothic Condensed Templates—Capital letters and numbers.

Template sizes—	80C*	100C*	120C	140C	175C	200C	240C	290C	350C	425C	500C	700C:	1000C:	1350C:
Pen sizes—	0000	0000	000	00	0	1	1	2	2	3	4	7	8	10

NEWS GOTHIC BOLD

A B C D E F G H I J K L M N O P Q R S T U V W X Y Z
0 1 2 3 4 5 6 7 8 9

Actual size of 61 0680-24PC

61 0680 News Gothic Bold Templates—Capital letters and numbers. When used with Pen 00 or 0, an outline is formed which can be readily filled in. Available in type point sizes:

Template sizes— 18PC* 24PC* 30PC* 36PC 42PC 48PC 60PC 72PC: 84PC: 96PC: 120PC: 144PC:

*Use only with Fine Groove Tracer Pin. †Use with Scriber 61 0015. •To order only.

OUTLINE GOTHIC

A B C D E F G H I J K L M N O P Q R S T U V W X Y Z &
0 1 2 3 4 5 6 7 8 9

Actual size of 61 0700-240C

61 0700 Outline Gothic Templates—Capital letters and numbers. (When used with Pen 00 or 0, an outline is formed which can be readily filled in.) Size 650 is approved by the U.S. Dept. of Commerce, Bureau of Public Roads, for titles on State and County maps.

Template sizes— 175C* 200C* 240C 290C 350C 425C 500C 650C 1000C| 1350C| 2000C|

NITSCHÉ BOLD

A B C D E F G H I J K L M N
O P Q R S T U V W X Y Z - &
0 1 2 3 4 5 6 7 8 9

Actual size of 61 0720-24PC

61 0720 Nitsché Bold Templates—Capital letters and numbers. When used with Pen 00 or 0, an outline is formed which can readily be filled in. Available in type point sizes:

Template sizes— 18PC* 24PC* 30PC* 36PC 42PC 48PC 60PC 72PC| 84PC| 96PC| 120PC| 144PC|

FRANKLIN GOTHIC

A B C D E F G H I J K L M N O P Q R S T U V W X Y Z
& (!?;"') \$ ¢ 0 1 2 3 4 5 6 7 8 9

Actual size of 61 0750-24PC

61 0750 Franklin Gothic Templates—Capital letters and numbers. When used with Pen 00 or 0, an outline is formed which can be readily filled in. Available in type point sizes:

Template sizes— 18PC* 24PC* 30PC* 36PC 42PC 48PC 60PC 72PC| 84PC| 96PC| 120PC| 144PC|

a b c d e f g h i j k l m n o p q r s t u v w x y z (!?;"')

Actual size of 61 0800-24PL

61 0800 Franklin Gothic Templates—Lower case letters. When used with Pen 00 or 0, an outline is formed which can be readily filled in. Available in type point sizes:

Template sizes— 18PL* 24PL* 30PL* 36PL 42PC 48PL 60PC 72PL| 84PL| 96PL| 120PL| 144PL|

Type point sizes referred to above are approximately hundredths of an inch. For instance —24PC, —24PL, or —24PCL is approximately 0.24 inch high. Illustrations are 24 point.

LEROY® Lettering Templates

ALTERNATE GOTHIC

A B C D E F G H I J K L M N O P Q R S T U V W X Y Z &
\$ 0 1 2 3 4 5 6 7 8 9

Actual size of 61 0850-24PC

61 0850 Alternate Gothic Templates—Capital letters and numbers. When used with Pen 00 or 0, an outline is formed which can be readily filled in. Available in *type point* sizes:

Template sizes— 18PC* 24PC* 30PC 36PC 42PC 48PC 60PC 72PC; 84PC; 96PC; 120PC; 144PC;

a b c d e f g h i j k l m n o p q r s t u v w x y z ? ! ; :

Actual size of 61 0900-24PL

61 0900 Alternate Gothic Templates—Lower case letters. When used with Pen 00 or 0, an outline is formed which can be readily filled in. Available in *type point* sizes:

Template sizes— 18PL* 24PL* 30PL 36PL 42PL 48PL 60PL 72PL; 84PL; 96PL; 120PL; 144PL;

SPARTAN MEDIUM

A B C D E F G H I J K L M N O P Q R S T U V W X Y Z &
0 1 2 3 4 5 6 7 8 9

Actual size of 61 0950-24PC

61 0950 Spartan Medium Templates—Capital letters and numbers. When used with Pen 00 or 0, an outline is formed which can be readily filled in. Available in *type point* sizes:

Template sizes— 24PC* 30PC 36PC 42PC 48PC 60PC 72PC; 84PC; 96PC; 120PC; 144PC;

SPARTAN BLACK

A B C D E F G H I J K L M N O P Q R S T U V W X Y Z &
(! ? ; :) % \$ € 0 1 2 3 4 5 6 7 8 9

Actual size of 61 1000-24PC

61 1000 Spartan Black Templates—Capital letters and numbers. When used with Pen 00 or 0, an outline is formed which can be readily filled in. Available in *type point* sizes:

Template sizes— 24PC* 30PC* 36PC 42PC 48PC 60PC 72PC; 84PC; 96PC; 120PC; 144PC;

a b c d e f g h i j k l m n o p q r s t u v w x y z (! ? ; :)

Actual size of 61 1050-24PL

61 1050 Spartan Black Templates—Lower case letters. When used with Pen 00 or 0, an outline is formed which can be readily filled in. Available in *type point* sizes:

Template sizes— 24PL* 30PL* 36PL 42PL 48PL 60PL 72PL; 84PL; 96PL; 120PL; 144PL;

*Use only with Fine Groove Tracer Pin. †Use with Scriber 61 0015. •To order only.

SPARTAN EXTRA BLACK

A B C D E F G H I J K L M N O P Q R S T U
V W X Y Z & 0 1 2 3 4 5 6 7 8 9 \$ % , ' ! ? () ' -

Actual size of 61 1100-24PC

61 1100 Spartan Extra Black Templates—Capital letters and numbers. When used with Pen 00 or 0, an outline is formed which can be readily filled in. Available in *type point* sizes:

Template sizes— 24PC* 30PC 36PC 42PC 48PC 60PC 72PC; 84PC; 96PC; 120PC; 144PC; 168PC:

STYMIE MEDIUM

A B C D E F G H I J K L M N O P Q R S T U V W X
Y Z & ; ! ? () ' 0 1 2 3 4 5 6 7 8 9 \$

Actual size of 61 1150-24PC

61 1150 Stymie Medium Templates—Capital letters and numbers. Available in *type point* sizes:

Template sizes— 12PC 14PC 18PC 24PC 30PC 36PC 42PC* 48PC 60PC

Pen sizes— 0 0 1 2 2 3 4 5 6

a b c d e f g h i j k l m n o p q r s t u v w x y z ; ! ? () ' -

Actual size of 61 1200-24PL

61 1200 Stymie Medium Templates—Lower case letters. Available in *type point* sizes:

Template sizes— 12PL 14PL 18PL 24PL 30PL 36PL 42PL 48PL* 60PL

Pen sizes— 0 0 1 2 2 3 4 5 6

CARTOGRAPHIC

A B C D E F G H I J K L M N O P Q R S T U
V W X Y Z & ! ! ? - : ; ! ! % 0 1 2 3 4 5 6 7 8 9

Actual size of 61 1250-24PC

61 1250 Cartographic Templates—Capital letters and numbers. When used with Pen 00 or 0, an outline is formed which can be readily filled in. Available in *type point* sizes:

Template sizes— 18PC* 24PC* 30PC* 36PC 42PC 48PC 60PC 72PC; 84PC; 96PC; 120PC; 144PC:

a b c d e f g h i j k l m n o p q r s t u v w x y z { ! ! ? - : ; ! ! }

Actual size of 61 1300-24PL

61 1300 Cartographic Templates—Lower case letters. When used with Pen 00 or 0, an outline is formed which can be readily filled in. Available in *type point* sizes:

Template sizes— 18PL* 24PL* 30PL* 36PL 42PL 48PL 60PL; 72PL; 84PL; 96PL; 120PL:

LEROY® Lettering Templates

BERNHARDT MODERN BOLD

ABCDEFGHIJKLMNOPQRSTUVWXYZ&(!:?)
\$\$¢0123456789

Actual size of 61 1350-24PC

61 1350 Bernhardt Modern Bold Templates—Capital letters and numbers. When used with Pen 00 or 0, an outline is formed which can be readily filled in. Available in *type point* sizes:

Template sizes— 24PC* 30PC* 36PC 42PC 48PC 60PC 72PC† 84PC‡• 96PC: 120PC: 144PC:

abcdefghijklmnopqrstuvwxyz (!:?)

Actual size of 61 1400-24PL

61 1400 Bernhardt Modern Bold Templates—Lower case letters and numbers. When used with Pen 00 or 0, an outline is formed which can be readily filled in. Available in *type point* sizes:

Template sizes— 24PL* 30PL* 36PL 42PL 48PL 60PL 72PL‡• 84PL‡• 96PL‡• 120PL‡• 144PL‡•

CASLON BOLD CONDENSED

ABCDEFGHIJKLMNOPQRSTUVWXYZ
&!;:0123456789

Actual size of 61 1450-24PC

61 1450 Caslon Bold Condensed Templates—Capital letters and numbers. When used with Pen 00 or 0, an outline is formed which can be readily filled in. Available in *type point* sizes:

Template sizes— 18PC* 24PC* 30PC 36PC 42PC 48PC 60PC 72PC† 84PC: 96PC: 120PC: 144PC:

abcdefghijklmnopqrstuvwxyz

Actual size of 61 1500-24PL

61 1500 Caslon Bold Condensed Templates—Lower case letters. When used with Pen 00 or 0, an outline is formed which can be readily filled in. Available in *type point* sizes:

Template sizes— 18PL* 24PL* 30PL 36PL 42PL 48PL 60PL 72PL† 84PL: 96PL: 120PL: 144PL:

OLD ENGLISH

A B C D E F G H I J K L M N O P Q R S T U
V W X Y Z & ' : , ! ? \$ 0 1 2 3 4 5 6 7 8 9

Actual size of 61 1550-24PC

61 1550 Old English Templates—Capital letters and numbers. When used with Pen 00 or 0, an outline is formed which can be readily filled in. Available in *type point* sizes:

Template sizes— 24PC* 30PC* 36PC 42PC 48PC 60PC 72PC† 84PC: 96PC: 120PC: 144PC:

abcdefghijklmnopqrstuvwxyz

Actual size of 61 1600-24PL

61 1600 Old English Templates—Lower case letters. When used with Pen 00 or 0, an outline is formed which can be readily filled in. Available in *type point* sizes:

Template sizes— 24PL* 30PL* 36PL 42PL 48PL 60PL 72PL† 84PL: 96PL: 120PL: 144PL:

*Use only with Fine Groove Tracer Pin. †Use with Scriber 61 0015. •To order only.

SCRIPT

ABCDEFGHIJKLMNOPQRSTUVWXYZ&\$1234567890¢
"-:;.!?abcdefghijklmnopqrstuwxxyz

Actual size of 61 1650-24PCL

61 1650 Script Templates—Capital letters and lower case letters, also numbers. Available in *type point sizes*:

Template sizes—18PCL* 24PCL* 30PCL 36PCL 42PCL 48PCL 60PCL 72PCL: 84PCL: 96PCL: 120PCL: 144PCL:

Pen sizes— 000 00 00 0 0 1 2 3 3 4 5 6

INFORMAL STYLE

ABCDEFGHIJKLMNOPQRSTUVWXYZ&"-:;.!?\$1234567890

Actual size of 61 1700-24PC

61 1700 Informal Style Templates—Capital letters and numbers. Available in *type point sizes*:

Template sizes—10PC* 12PC* 14PC* 18PC 24PC 30PC 36PC 42PC 48PC 60PC

Pen sizes— 000 000 000 000 00 0 1 1 2 3

FREEHAND

ABCDEFGHIJKLMNOPQRSTUVWXYZ&
,-:;.!?\$1234567890

Actual size of 61 1750-24PC

61 1750 Freehand Lettering Templates—Capital letters and numbers. When used with Pen 00 or 0, an outline is formed which can be readily filled in. Available in *type point sizes*:

Template sizes—24PC* 30PC* 36PC* 42PC 48PC 60PC

a b c d e f g h i j k l m n o p q r s t u v w x y z , - : ; . ! ?

Actual size of 61 1800-24PL

61 1800 Freehand Lettering Templates—Lower case letters. When used with Pen 00 or 0, an outline is formed which can be readily filled in. Available in *type point sizes*:

Template sizes—24PL* 30PL* 36PL* 42PL 48PL 60PL

SHADOW

ABCDEFGHIJKLMNOPQRSTUVWXYZ
& 0 1 2 3 4 5 6 7 8 9 \$

Actual size of 61 1850-240C

61 1850 Shadow Templates—Capital letters and numbers

Template sizes—120C* 140C* 175C* 200C* 240C* 290C 350C 425C 500C

Pen sizes— 000 00 0 0 1 2 2 3 4

Type point sizes referred to above are approximately hundredths of an inch. For instance —24PC, —24PL, or —24PCL is approximately 0.24 inch high. Illustrations are 24 point.

MICROFONT

A B C D E F G H I J K L M N O P Q R S T U V W X Y Z . , : ; | 2 3 4 5 6 7 8 9 0
 = ÷ + - ± @ & * ? # \$ % ' () [] ° ! ¢ \$ / _ ∞ Δ ≈ ~ ∅ ⊥ < > μ α √ σ δ Σ
 γ π β θ ω Ω ∴ ∥

Actual size of 61 1980-4

61 1980 MICROFONT Templates—Capital letters, numbers and symbols. Available in millimeter height sizes:

Template sizes— 3.0* 4.0 5.0 6.0
 Pen sizes— 0 1 2 2

61 1985 MICROFONT Templates—Capital letters and numbers. Available in millimeter height sizes:

Template sizes— 10.0 12.0
 Pen sizes— 4 5

61 1990 MICROFONT Templates—Symbols only. Available in millimeter height sizes:

Template sizes— 10.0 12.0
 Pen sizes— 4 5

MICROFONT conforms with National Microfilm Association drafting standards.
See page 6 for MICROFONT lettering set.

RUSSIAN

А а Б б В в Г г Д д Е е Ж ж З з И и К к Л л М м Н н О о П п Р р С с Т т У у Ф ф Х х Ц ц Ч ч Ш ш Щ щ Ъ ъ Ы ы Ь ь Э э
 Ю ю Я я 0 1 2 3 4 5 6 7 8 9

Actual size of 61 2050-24PC

61 2050 Russian Templates—Capital letters and numerals and the lower case letters that differ from their capitals. When lettering work combines capitals and lower case, for lower case use template two sizes smaller than for capitals. Available in type point sizes:

Template sizes— 8PC* 10PC 12PC 14PC 18PC 24PC 30PC* 36PC 42PC 48PC* 60PC
 Pen sizes— 000 00 0 1 2 3 4 4 5 6 6

HEBREW

א אב ג ד ה ו ז ח ט י כ ל מ נ ס ע פ צ ק ר ש ת

Actual size of 61 2100-240C

61 2100 Hebrew Templates—Capital letters.

Template sizes— 80C* 100C 120C 140C 175C 200C 240C 290C* 350C* 425C 500C
 Pen sizes— 000 00 0 1 2 3 3 4 4 5 6

ISOMETRIC

, ABCDEFGHIJKL·MN·OU·VWXY Z & " = 0 1 2 3 4 5 6 7 8 9 ·
 , ABCDEFGHIJKL·MN·OU·VWXY Z & " = 0 1 2 3 4 5 6 7 8 9 ·

Actual size of 61 2150-200C

61 2150 Isometric Templates—Capital letters and numbers correctly sloped for isometric drawings.

Template sizes— 100C 120C 140C 175C 200C
 Pen sizes— 00 0 1 2 3

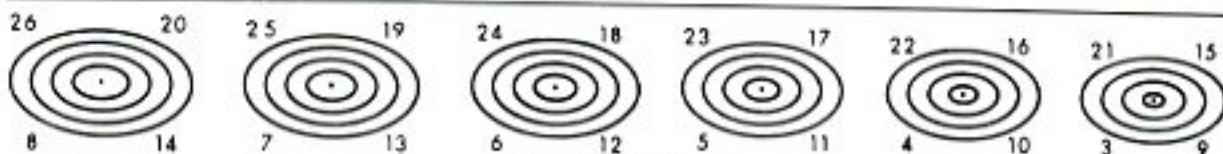

Actual size of 61 2200

•61 2200 Isometric Circle Templates—Forms 24 ellipses which are the isometric representation of circles of diameters ranging from 3/32 to 1 1/16 inches. These ellipses can be formed in all three isometric planes.

Type point sizes referred to above are approximately hundredths of an inch. For instance —24PC, —24PL, or —24PCL is approximately 0.24 inch high. Illustrations are 24 point.

LEROY® Symbol Templates

MAP SYMBOLS

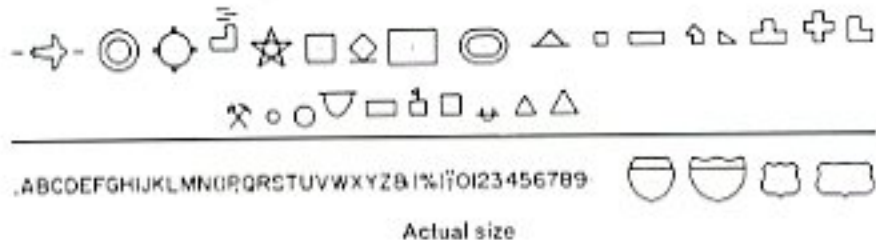

61 2250* Map Symbol Template (with Capital Letters and Numbers, size 80C). Forms map symbols as illustrated, in addition to all capital letters and numbers that can be formed with template No. 61 0250 size 80C. While each map symbol is complete in itself, by combining them,

additional symbols can be formed. Map symbols are selected from the Manual of Standard Procedures (April 1950) for preparing State and County Maps, by the U. S. Department of Commerce, Bureau of Public Roads. (Use Pen 000, 00 or 0)

MILITARY MAP SYMBOLS

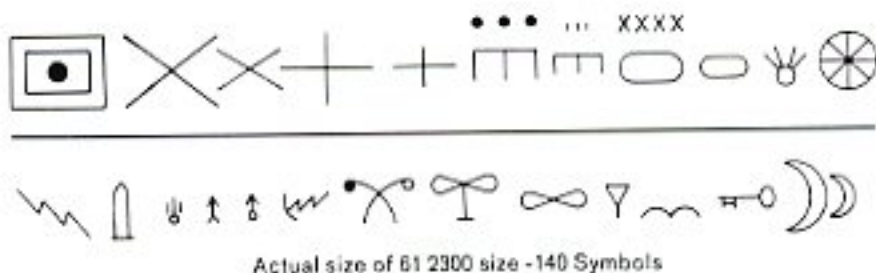

61 2300 Military Map Symbol Templates. Form symbols as illustrated. Size numbers (140, 200, 290) indicate correct size Military Map Symbol Template to use with corresponding size LEROY Standard series Lettering Template. While each map symbol is complete in itself, by combining them, additional symbols can be formed. Developed in co-operation with the U. S. Marine Corps.

Template sizes	140	200	290
Pen sizes	1	3	4

GEOLOGICAL SYMBOLS



61 2350 Geological Symbol Templates. Form symbols as illustrated. Size numbers (120, 175) indicate correct size Mathematical Symbol Template to use with corresponding size LEROY Standard series Lettering Template. Developed in co-operation with the U. S. Geological Survey, Washington, D.C.

Template sizes	120*	175
Pen sizes	000, 00 or 0	000, 00 or 0

*Use only with Fine Groove Tracer Pen.

"NORTH POINTER" DESIGN TEMPLATES

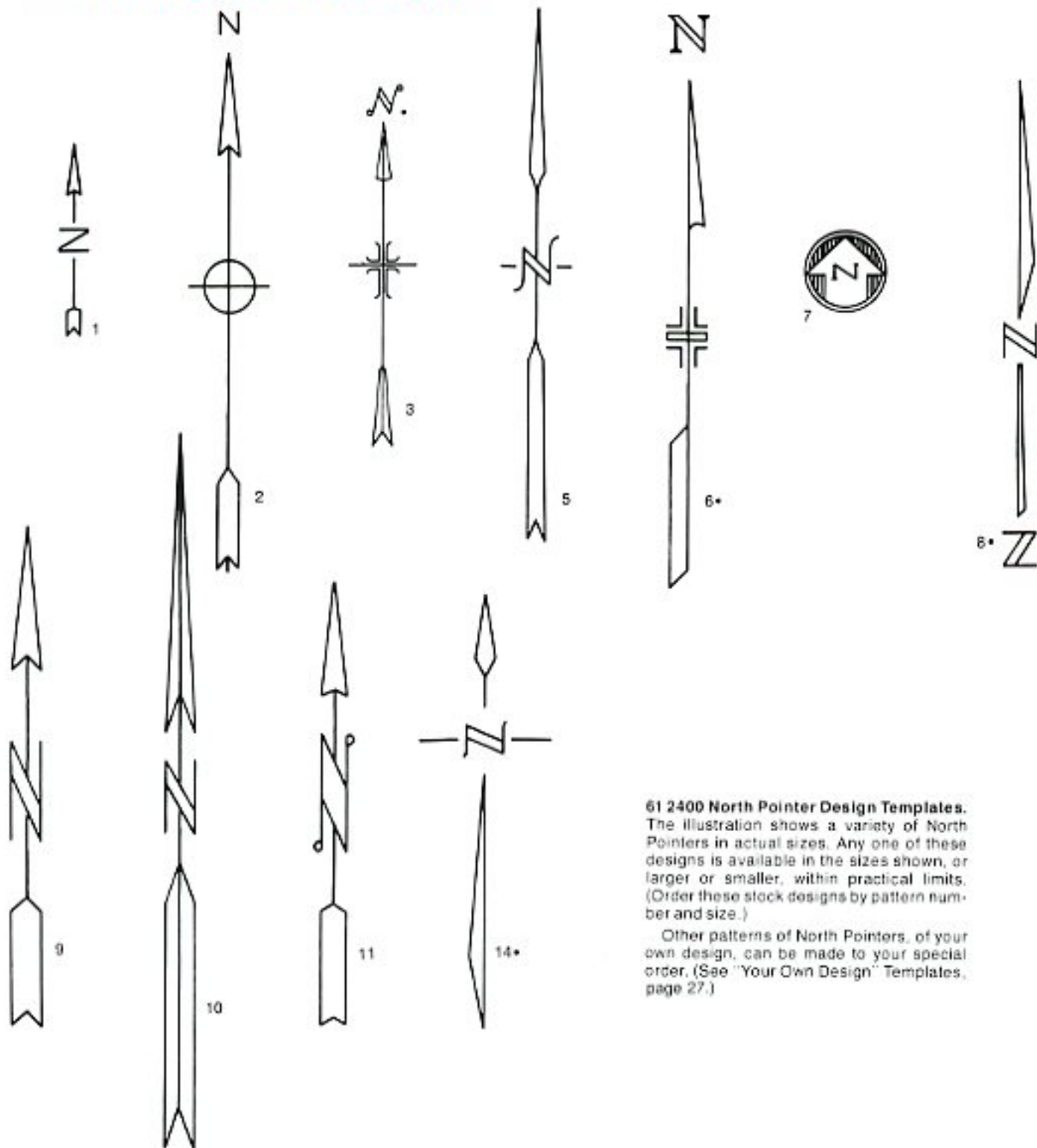

61 2400 North Pointer Design Templates.
 The illustration shows a variety of North Pointers in actual sizes. Any one of these designs is available in the sizes shown, or larger or smaller, within practical limits. (Order these stock designs by pattern number and size.)

Other patterns of North Pointers, of your own design, can be made to your special order. (See "Your Own Design" Templates, page 27.)

LEROY® Symbol Templates

ELECTRICAL SYMBOLS

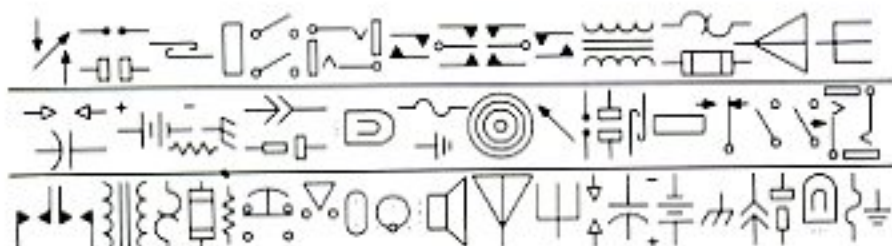

Actual size of 61 2450 size 10 symbols

61 2450 size 10. Electrical Symbol Template—Forms electrical symbols for power, communication and electronic wiring diagrams. The symbols are of the form and size shown in American Standard Association Bulletin Y32.2-1954 "Graphical Symbols for Electrical Diagrams" and Military Specification MIL-STD-15A. (Use Pen 000 or 00).

61 2450 size 15. Electrical Symbol Template—Same as 61 2450 size 10 except 1½ times size (use Pen 00 or 0).

61 2450 size 20. Electrical Symbol Template—Same as 61 2450 size 10 but twice size (use Pen 0 or 1).

ELECTRONIC TUBE SYMBOLS

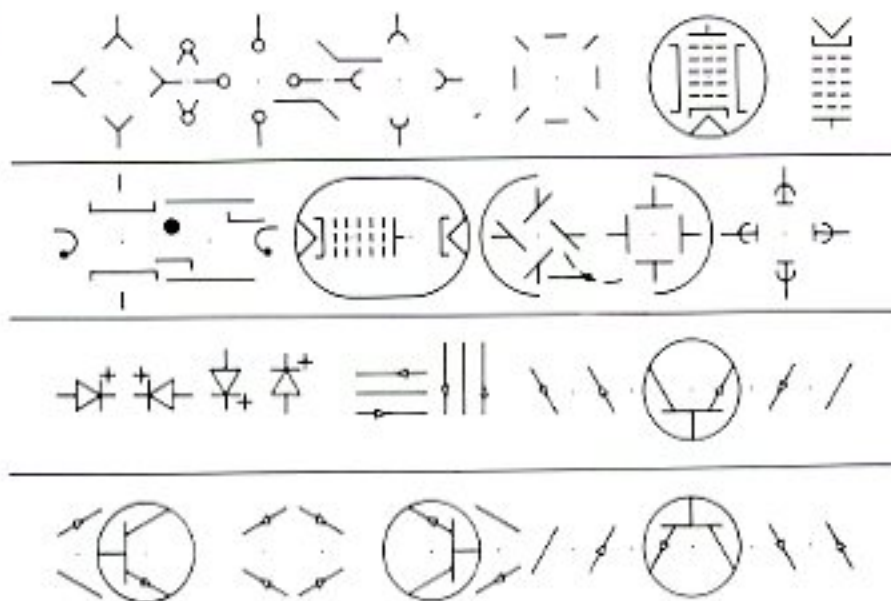

Actual size of 61 2501 size 10 symbols

61 2501 size 10. Electronic Tube Symbol Template—Forms practically all of the symbols used for various types of electronic tubes and semi-conductor devices. For use with Electrical Symbol template 61 2450 size 10. Symbols are of the form and size shown in ASA Bulletin Y32.2-1952 and Military Specification MIL-STD-15-1 dated 30 Oct. 1961 (use Pen 000 or 00).

This template permits symbols to be made in both horizontal and vertical directions to suit the direction of current flow. This new design also enables the various positions of the same symbol to be made without chang-

ing the template from the normal horizontal position.

61 2501 size 15. Electronic Tube Symbol Template—Same as 61 2501 size 10 but 1½ times size. For use with Electrical Symbol template 61 2450 size 15 (use Scriber 61 0015 and Pen 00 or 0).

61 2501 size 20. Electronic Tube Symbol Template—Same as 61 2501 size 10 but twice size. For use with Electrical Symbol template 61 2450 size 20 (use Scriber 61 0015 and Pen 0 or 1).

FRACTION TEMPLATE

+ , ⁰/₀ | 2 3 4 5 6 7 8 9 ± ⁰/₁ ²/₂ ³/₃ ⁴/₄ ⁵/₅ ⁶/₆ ⁷/₇ ⁸/₈ ⁹/₉ ± (%)

61 2600 Fraction Template. Will produce numbers in sizes 120C, 140C, 175C and 240C; and fractions with the numerators and denominators in sizes 80C, 100C or 120C.

MATHEMATICAL SYMBOLS

{ } [] ∫ √ ∑ ± ∓ ≅ ≠ ≈ α ≤ ≥ ~ ÷ + × ∞ Δ ∇ \ ⊥ ! √ ← → # ∂ d e ^{0 1 2 3 4 5 6 7 8 9 0 1 1}

Actual size of 61 2650 size 120

61 2650 Mathematical Symbol Templates. Form symbols as illustrated. Size numbers (120, 140, etc.) indicate correct size Mathematical Symbol Template to use with corresponding size LEROY Standard series Lettering Template.

Template sizes	120	140	175	200	240
Pen sizes—	0	1	2	3	3

MUSIC SYMBOLS

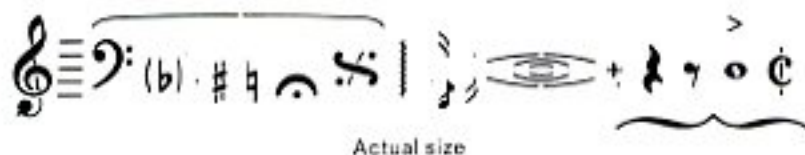

61 2700 Music Symbol Template. Forms symbols as illustrated. This template is specifically designed for use by professional music copyists and music engravers. It provides the user with any combination of music symbols

necessary for professional use. Lines of the staff are in red for reference only and are not engraved for drawing. (Use Pen 000 or 00.) Other spacing of staff lines may be furnished on special order.

LEROY[®] Symbol Templates

MUSICOPY SYMBOLS



•61 2702* Musiccopy—Symbol Template. Forms symbols as illustrated. This template is specifically designed for use by professional music copyists and music engravers. It provides the user with any combination of music sym-

bols necessary for professional use. Staff lines in red on template are for reference only and are not engraved for drawing (use Pen size 000 or 00). Other spacing of staff lines may be furnished on special order.

SLUR-TIE



Two thirds actual size

•61 2704* Musiccopy—Slur-Tie Template. Forms virtually every size slur-tie needed in the music field. When combined with Musiccopy Template No. 61 2702 any variation of music symbols and slur-ties may be made (use Pen size 000 or 00).

*Use only with Fine Groove Tracer Pin.

GRAPH SYMBOLS

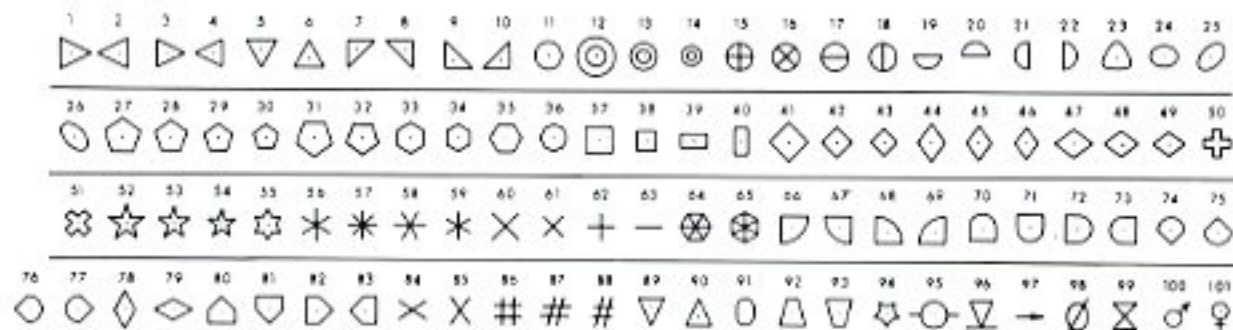

• **61 2750 Graph Symbols Template.** The illustration shows a variety of Graph Symbols in actual sizes. Any one of these stock designs is available (to order only) in the sizes shown, or larger or smaller, within practical limits.

(Order these stock designs by pattern number and size.)

Other Graph Symbols, of your own design, can be made to your special order. (See "Your Own Design" Templates below.)

"YOUR OWN DESIGN TEMPLATES"

• **61 2800 Templates,** in 9 1/2, 12 or 15 in. lengths, to order, with frequently used phrases for drawings or title blocks, or with other wording, in standard LEROY capitals or capitals and lower case letters and numerals. Characters available in any size from 80 to 500.

• **61 2850 Templates,** with symbols made to your own design can save you a great deal of time and needless repetitive work. Designs, symbols, trade marks, signatures, title blocks and other devices have to be drawn many times. With a LEROY Template made specially for you these can be drawn in a few seconds.

Send us a sketch or reproduction of any design that you would like to have on LEROY Templates and ask for quotation.

Bear in mind these few points:

1. Maximum height for characters is 2 inches.
2. Lines should not be finer than the LEROY 000 Pen can draw (.010 in. width).
3. Spaces between adjacent lines should not be less than the width of a LEROY 00 Pen line (.013 in.).
4. For characters or symbols with heavily inked areas or varying line widths, LEROY Templates are designed to draw these in outline, to be filled in afterwards.

OTHER MISCELLANEOUS LETTERING TEMPLATES TO ORDER

If you have use for special LEROY Templates with styles of alphabets and numbers other than those shown in this booklet, let us know your requirements. Send us a sketch or a specimen of the type of letters and numerals you would like to have. We will gladly offer suggestions and quote prices.

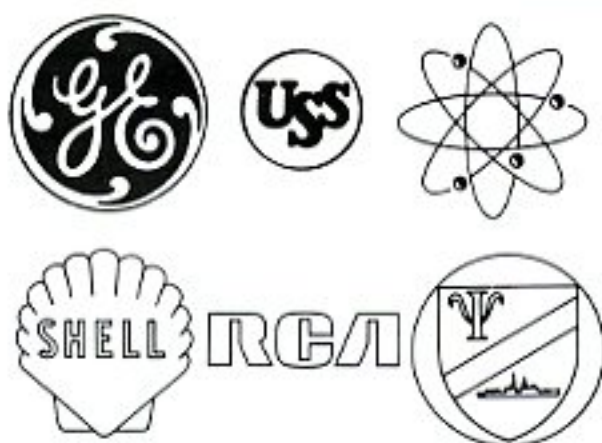

ABCDEF GHI

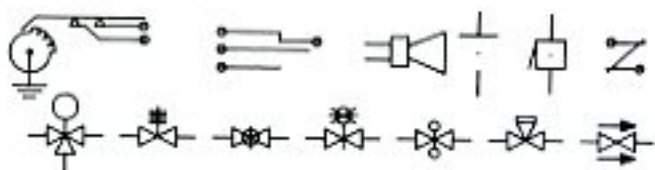
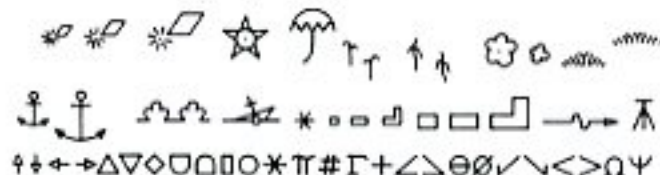

• To order only.

LEROY® Pens



Fewer refills — Designed for many hours of uninterrupted lettering, the LEROY Reservoir Pen will hold enough ink to draw a straight line approximately 1200 feet.

Ink always visible — The cartridge is airtight, made of non-porous, translucent, unbreakable material. The ink level is clearly shown.

Easy to clean — A tiny weighted needle inside the feed tube assures a clear passage of ink from the reservoir to the point. Light vertical shaking of the pen sets this needle in motion, removing any particles which may settle in the tube when the pen is set aside for short periods. The needle also provides efficient cleaning action when you wash out the pen.

Color coded — LEROY Reservoir Pens are color-coded and numbered for immediate identification of point size and to prevent mismates when cleaning.



Airtight cap prevents ink from drying in points — The design of the pen cap provides an airtight seal (1) that prevents air from entering the air channel of the ink flow-control system. In addition, the open tip of the point is totally sealed (2) against a pliable, impervious material within the cap liner assembly.

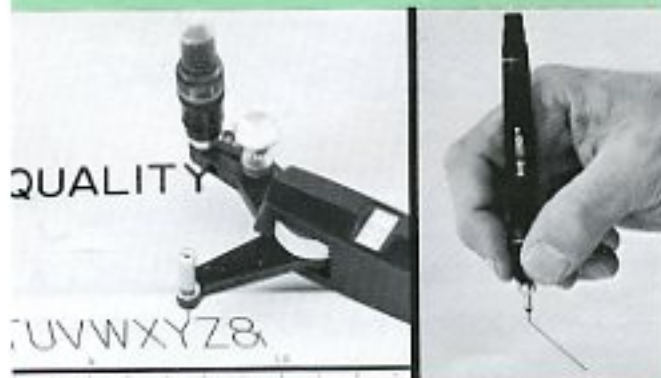

Dual use — LEROY Reservoir Pens are ideal for scribe use or hand drafting. When used with holder 61 0055, the slim-point design of the pen assures accurate line placement along a straightedge, curve or triangle, and it is ideal for free-hand sketching and drawing.

LEROY® RESERVOIR PENS for controlled lettering & line drawing



61 0051* LEROY Stainless Steel Reservoir Pens — Sizes 0000, 000, 00, 0, 1, 2, 3, 4, 5, 6, 8, 10, 12 and 14. Pens are threaded to accept LEROY Pen Holder 61 0055 for use as a free-hand drawing and ruling pen. Pen sizes 0000 to 5 have a thicker tip and a "step" in the diameter, which permits a free ink flow for clean, sharp lines. Risk of smearing caused by capillary action is eliminated. Sizes 0000 through 5 have stainless steel tips, sizes 6, 8, 10, 12 and 14 have plastic tips.

61 0052* Stainless Steel Replacement Points — Sizes 0000, 000, 00, 0, 1, 2, 3, 4, 5, 6, 8, 10, 12 and 14. For use with 61 0051 Reservoir Pens. Sizes 0000 through 5 have stainless steel tips; sizes 6, 8, 10, 12 and 14 have plastic tips.

61 0053* LEROY Jewel Tip Reservoir Pens — Sizes 0000, 000, 00, 0, 1, 2, 3, 4, 5. Same as 61 0051 except with jewel tips that are designed for drafting on film and will outlast stainless steel tip Reservoir Pens many times over.

61 0054* Jewel Tip Replacement Points — Sizes 0000, 000, 00, 0, 1, 2, 3, 4, 5. For use with 61 0053 LEROY Jewel Tip Reservoir Pens.

61 0055 Reservoir Pen Holder — Designed to hold individual LEROY Reservoir Pens so they can be used for free-hand drawing, sketching, ruling or following curves. Pens can be easily inserted or removed.

61 0062 LEROY Stainless Steel Reservoir Pen Set — Contains 7 Reservoir Pens (00, 0, 1, 2, 3, 4 and 5), holder, empty ink filler bottle and pen cleaner bottle, packed in a specially designed revolving caddy that has capacity to hold up to a dozen pens and three holders. The base of the caddy holds a sponge for humidifying, so pens stored uncapped and point down won't dry out. Set furnished with clamp to attach unit to board or table top.

61 0063 LEROY Jewel Tip Reservoir Pen Set — Same as 61 0062 except Reservoir Pens have jewel tips (00, 0, 1, 2, 3, 4 and 5).

61 0064 LEROY Stainless Steel Reservoir Pen Set — Same as 61 0062 but contains 8 Standard Reservoir Pens (000, 000, 0, 1, 2, 3, 4, and 5).

PEN SIZES AND LINE WIDTHS

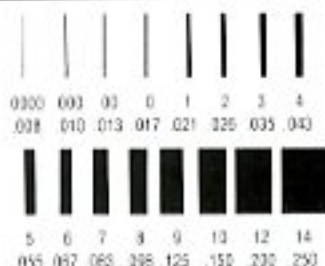

*Specify Size

LEROY® STANDARD PENS



HANDLE A VARIETY OF LETTERING JOBS — LEROY Standard Pens were designed to handle all types of lettering work. They are most effective however on small lettering jobs or those in which a number of pens are required.

LONG WEARING POINTS — The narrowest line pens (0000 to 1) have stainless steel lips, and the very fine stainless steel wire of the "cleaner" is reinforced for about half its length by stainless steel tubing inserted into the body of the "cleaner".

CORROSION RESISTANT — LEROY Pens resist the corrosive effects of moisture.

61 0070* LEROY Standard Lettering Pens—Sizes 0000, 000, 00, 0, 1, 2, 3, 4, 5, 6, 7, 8, 9, 10, 12, 14.

61 0100* Cleaning Pins — For LEROY Pens No. 61 0070. Sizes 0000 to 14.

61 0130* LEROY Long Point Lettering Pens — Sizes 0000, 000, 00, 0, 1, 2, 3, 4, 5, 6, 7, 8, for lettering or use with straightedges, curves and cut-out templates. Widths of lines are the same as LEROY Lettering Pens No. 61 0070.

61 0160* Long Point Cleaning Pins — For LEROY Long Point Lettering Pens 61 0130. Sizes 0000 to 8.

* Specify Size



61 0191 LEROY Standard Pen Set — Contains 8 Standard Pens No. 61 0070 sizes 1, 2, 3, 4, 5, 6, 7, 8, with empty spaces for 12 additional pens in convenient plastic box.

61 0192 LEROY Pen Caddy — Same as furnished with 61 0191 set but without pens



61 3075 LEROY Standard Penholder — Contour-designed to afford ease and comfort for free-hand lettering. The penholder is equipped with a clamp which permits quick insertion and removal of LEROY pens sizes 0000 to 8. A simple turn of the handle tightens or releases the clamp.

61 3080 LEROY Standard Penholder — Same as 61 3075 but used with LEROY Pens sizes 9 to 14.

61 3035 Socket Holder—For freehand lettering with LEROY Standard Pens, sizes 0000 to 8. Fits regular penholders.

LETTERING PEN SELECTION GUIDE See page 30 for LEROY Professional Pens, page 34 for Metric.

PEN SIZE	RESERVOIR				STANDARD		LONG POINT	
	STAINLESS STEEL LETTERING PENS 61 0051	STAINLESS STEEL REPLACEMENT POINTS 61 0052	JEWEL TIP LETTERING PENS 61 0053	JEWEL TIP REPLACEMENT POINTS 61 0054	LETTERING PENS 61 0070	CLEANING PINS 61 0100	LETTERING PENS 61 0130	CLEANING PINS 61 0160
0000	•	•	•	•	•	•	•	•
000	•	•	•	•	•	•	•	•
00	•	•	•	•	•	•	•	•
0	•	•	•	•	•	•	•	•
1	•	•	•	•	•	•	•	•
2	•	•	•	•	•	•	•	•
3	•	•	•	•	•	•	•	•
4	•	•	•	•	•	•	•	•
5	•	•	•	•	•	•	•	•
6	•	•	•	•	•	•	•	•
7	•	•	•	•	•	•	•	•
8	•	•	•	•	•	•	•	•
9	•	•	•	•	•	•	•	•
10	•	•	•	•	•	•	•	•
12	•	•	•	•	•	•	•	•
14	•	•	•	•	•	•	•	•

When ordering specify product number and pen size.

LEROY® Professional Pens-Standard

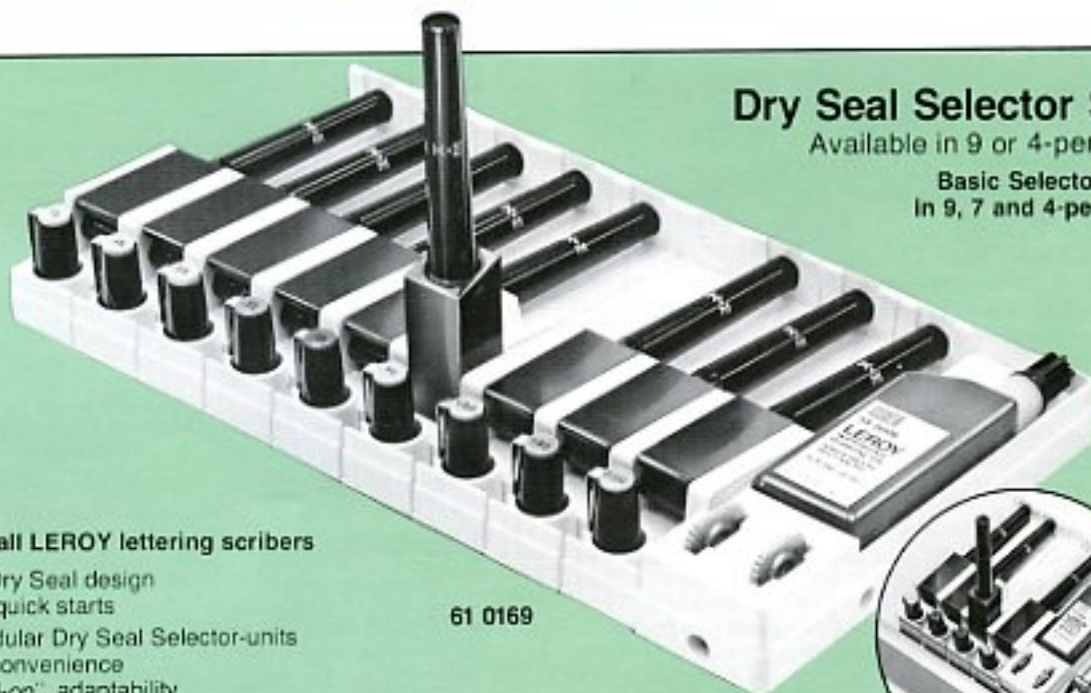

Dry Seal Selector Sets

Available in 9 or 4-pen units

Basic Selector Trays
In 9, 7 and 4-pen units

Pens fit all LEROY lettering scribers

- Unique Dry Seal design assures quick starts
- New modular Dry Seal Selector-units provide convenience and "add-on" adaptability

61 0169



Modular Concept



Each Dry Seal Selector unit has been cleverly designed with slide-locks so you may add or subtract from your pen selection to satisfy your individual requirements.

To Insure Instant Startup
After each use, lower pen into clamped, horizontal position, or securely thread on cap.



LEROY Professional Pens are available in nine standard sizes from -0000 to -5. They are ideal for technical drafting and also fit all LEROY lettering scribers. The unique Dry Seal design assures quick starts and the modular Dry Seal Selection units provide convenience and "add-on" adaptability.

Dry Seal Selector Sets

61 0169 LEROY 9-Pen DSS Set, Stainless Tips – Contains 9 Professional Pens with stainless tips in standard point sizes: 0000, 000, 00, 0, 1, 2, 3, 4 and 5; dry seal pen caps; Dry Seal Selector tilt holder units; 1 modular ink pack unit with ¾ oz. bottle LEROY ink (58 0006), 2 nib keys, board clamp; clear plastic cover. Double dry seal feature in both Dry Seal Selector tilt holder and pocket-clip pen cap to assure quick starts whether pen is stored in DSS holder or pocket.

61 0171 LEROY 9-Pen DSS Set, Jewel Tips – Same as 61 0169 but with tips for outstanding wear resistance and exceptionally smooth drafting. Will outlast stainless tips many times over.



61 0170

61 0170 LEROY 4-Pen DSS Set, Stainless Tips – Contains 4 Professional Pens with stainless tips in standard point sizes: 00, 0, 1 and 2; dry seal pen caps; 4 modular Dry Seal Selector tilt holder units; 1 modular ink pack unit with ¾ oz. bottle LEROY ink (58 0006), 2 nib keys, board clamp; clear plastic cover.

61 0172 LEROY 4-Pen DSS Set, Jewel Tips – Same as 61 0170 but with jewel tips.



61 0173

Basic Selector Tray Sets

61 0173 LEROY 9-Pen Set in Basic Selector Tray, Stainless Tips — Contains 9 Professional Pens with stainless tips in standard point sizes: 0000, 000, 00, 0, 1, 2, 3, 4 and 5; dry seal pen caps: ¼ oz. bottle LEROY ink (58 0006), 1 nib key; basic selector tray with provision to hold 7 pens in upright position during use.

61 0176 LEROY 9-Pen Set in Basic Selector Tray, Jewel Tips — Same as 61 0173 but with jewel tips.

61 0174 LEROY 7-Pen Set in Basic Selector Tray, Stainless Tips — Same as 61 0173 but with 7 pens, dry seal pen caps, ¼ oz. bottle LEROY ink and 1 nib key. Pen sizes: 00, 0, 1, 2, 3, 4, and 5.

61 0177 LEROY 7-Pen Set in Basic Selector Tray, Jewel Tips — Same as 61 0174 but pens have jewel tips.

61 0175 LEROY 4-Pen Set in Basic Selector Tray, Stainless Tips — Same as 61 0173 but with 4 pens, dry seal pen caps, ¼ oz. bottle LEROY ink and 1 nib key. Pen sizes: 00, 0, 1, and 2.

61 0178 LEROY 4-Pen Set in Basic Selector Tray, Jewel Tips — Same as 61 0175 but pens have jewel tips.

PEN SIZES AND LINE WIDTHS



Professional pens for technical drawing and LEROY controlled lettering

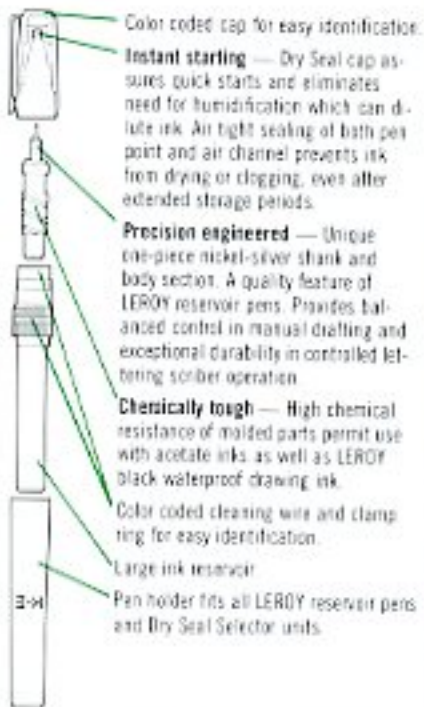

Modular design provides "add on" flexibility to suit your exact needs



61 0049

Modular Dry Seal Selectors

Pen holders included for use with LEROY reservoir pens 61 0051 and 61 0053

61 0046 Dry Seal Selector for 1 pen — One tilt holder unit with pen holder. Can be attached to other units to form set.

61 0048 Dry Seal Selector for 4 pens — Contains four tilt holder units, four pen holders, ink pack with ¼ oz. bottle LEROY ink, 2 nib keys, mounting clamp and clear plastic cover.

61 0049 Dry Seal Selector for 9 pens — Contains nine tilt holder units, nine pen holders, ink pack with ¼ oz. bottle LEROY ink, 2 nib keys, mounting clamp and clear plastic cover.

Individual Professional Pens

***61 0165 LEROY Standard Professional Pen, Stainless Tip, DSS** — Cap, nib key and Dry Seal Selector Module. Available in 9 standard point sizes: 0000, 000, 00, 0, 1, 2, 3, 4, and 5.

***61 0167 LEROY Standard Professional Pen, Jewel Tip, DSS** — Same as 61 0165 but with jewel tip.

***61 0166 LEROY Standard Professional Pen only, Stainless Tip** — Cap and nib key. Available in 9 standard point sizes: 0000, 000, 00, 0, 1, 2, 3, 4, and 5.

***61 0168 LEROY Standard Professional Pen only, Jewel Tip** — Same as 61 0166 but with jewel tip.



61 0165

61 0166

Replacement Points

***61 0162 Stainless Steel Replacement Points** — Available in nine sizes: 0000, 000, 00, 0, 1, 2, 3, 4, and 5.

***61 0163 Jewel Tip Replacement Points** — Same as 61 0162 but jewel tip.

61 0164 Tungsten Carbide Tip Replacement Points — Same as 61 0162 but tungsten carbide tip.



61 0162

Pen Holder

61 0031 LEROY Pen Holder only — Adapts LEROY reservoir pens 61 0051 and 61 0053 for use in Dry Seal Selector unit.



61 0045 Ink Pack — Contains ¼ oz. bottle LEROY ink, 2 nib keys, mounting clamp. Forms end unit for adding on Dry Seal Selector units. Clamps to board or table.
58 0006 LEROY Ink — ¼ oz. plastic bottle of LEROY waterproof drawing ink, opaque black for vellum and film.

*When ordering specify pen number corresponding to point size selected from Line Width Chart.

LEROY® Metric Standard Lettering Sets

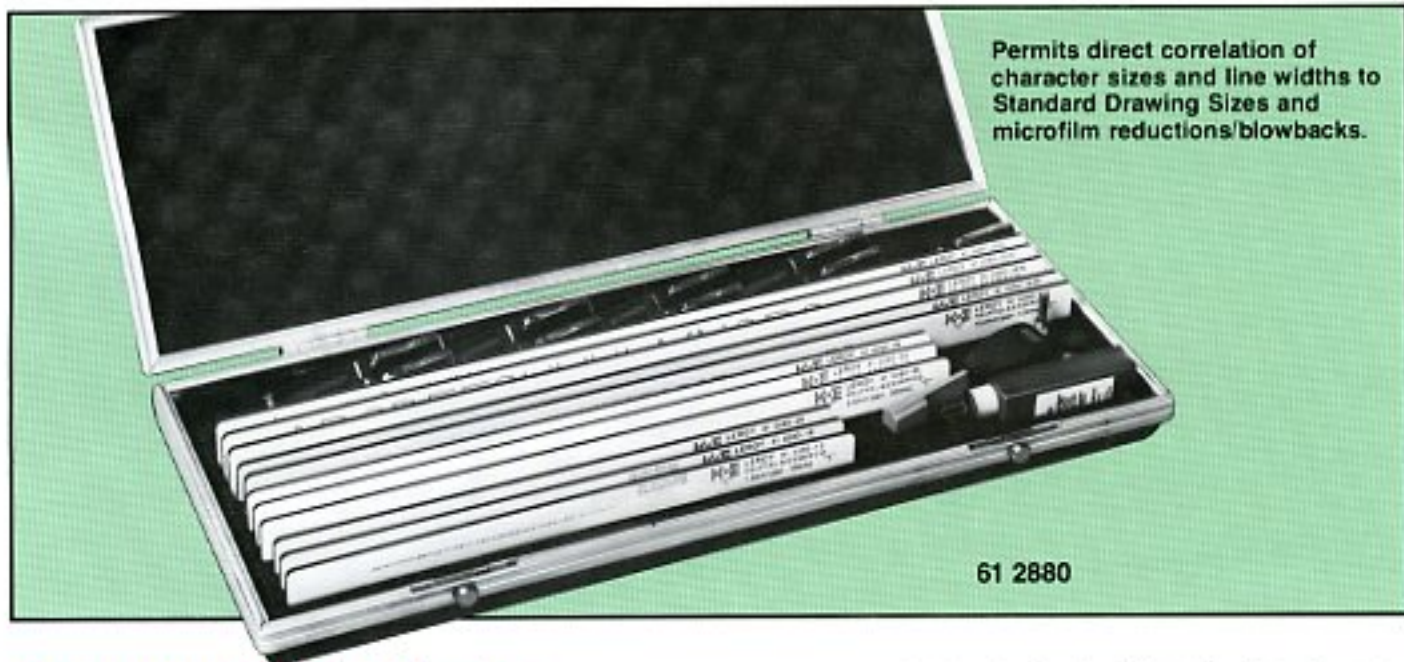

Permits direct correlation of character sizes and line widths to Standard Drawing Sizes and microfilm reductions/blowbacks.

61 2880

Now you can precisely determine the optimum character size for any controlled lettering application

The letter size and line width recommendations of an internationally accepted standard have been incorporated into the specifications of the LEROY Metric Standard Templates and Metric Technical Pens. The result: a logical system emerges whereby both letter sizes and line widths follow an identical geometric size progression based on the $\sqrt{2}$ (1.414). By pairing each template size in the system with the corresponding pen size, a constant ratio of 10:1 is always maintained between letter size and line width.

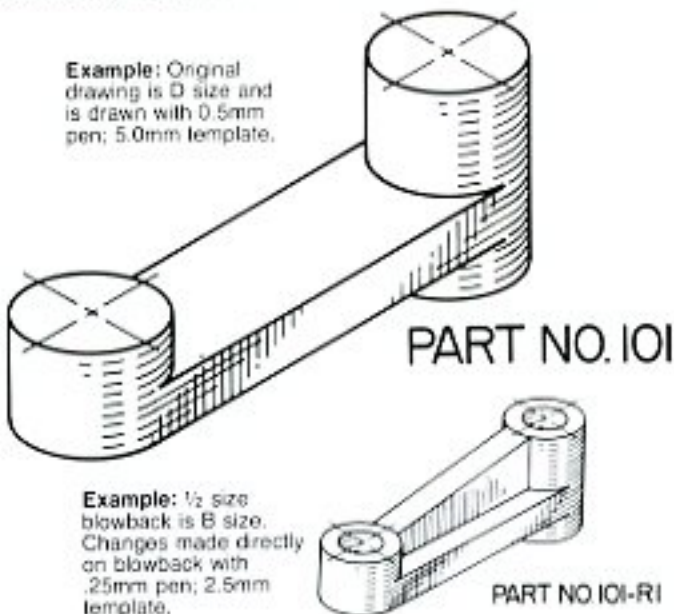

61 2880 LEROY Metric Standard Lettering Set—Contains a complete set of 9 Metric Technical Pens and 9 matching Metric Standard Templates (11 template sections); one Adjustable Scriber 61 0004; one ¾ oz. bottle of LEROY® Ink 58 0006; and 2 nib keys. In formed plastic case.

61 2890 LEROY Metric Standard Lettering Set—Contains 4 Metric Technical Pens in point sizes 0.25mm, 0.35mm, 0.50mm and 0.70mm; 4 Metric Standard Templates in capital letter sizes 2.5mm, 3.5mm, 5.0mm and 7.0mm; one Adjustable Scriber 61 0004; one ¾ oz. bottle LEROY Ink 58 0006; and 2 nib keys. In formed plastic case.

Product No.		Set No.	Set No.
Metric Pen	Template	61 2880	61 2890
61 0023-200	*61 0260-200C	•	
	-200L	•	
61 0023-140	*61 0260-140C	•	
	-140L	•	
61 0023-100	61 0260-100	•	
61 0023-70	61 0260-70	•	•
61 0023-50	61 0260-50	•	•
61 0023-35	61 0260-35	•	•
61 0023-25	61 0260-25	•	•
61 0023-18	61 0260-18	•	
61 0023-13	61 0260-13	•	

*The large 10mm and 20mm characters require two template sections to incorporate a complete range of capital letters, lower case letters, numbers and symbols. Both the 61 0260-140L and 61 0260-200L produce lower case letters, numbers and symbols. The 61 0260-140C and 61 0260-200C produce capital letters as illustrated on page 33.

LEROY® Metric Standard Templates

With the exception of letter style,* LEROY Metric Standard Templates and Metric Technical Pens conform to the dimensional characteristics set forth in International Standard ISO 3098:1 for Technical Drawings and Lettering. This International Standard specifies the characteristics of lettering used on technical drawings and associated documents. It concerns primarily the features of legibility, uniformity, and suitability for microfilming and other photographic reproduction.



Easy-to-Set 15° Slant Setting—The 15° position is recommended as maximum slant for maintaining legibility in reductions.

Scriber 61 0003 features a gauge mark on tracer pin arm for 15° slant setting.



On other LEROY scribes just set the distance between the pen and tracer pin equal to the distance between the positioning targets on the template and the scribe is set to produce a 15° slant.

61 0260 LEROY Metric Standard Templates—Available individually in 9 Metric Standard character sizes (11 separate template sections). All 9 sizes produce capital and lower case letters, numbers and symbols. When ordering, specify size.

Template No.	61 0260	-13	-18	-25	-35	-50	-70	-100	-140C	-140L	-200C	-200L
Character Ht. (Caps/Numerals)		1.3 mm	1.8 mm	2.5 mm	3.5 mm	5.0 mm	7.0 mm	10.0 mm	14.0 mm	14.0 mm	20.0 mm	20.0 mm

*The letter style produced by LEROY Metric Standard Templates is the same as that of the widely-used LEROY Engineering Standard Templates (K&E No. 61 0300 Series). This style forms the basis of LEROY controlled lettering systems throughout the world and differs from ISO letter style recommendations in certain letter shape characteristics only.

Microfilm Line Width and Letter Size Guide

Generally, microfilm image line widths of less than 15 microns (0.0006") do not yield satisfactory blowback reproductions. The

chart below indicates the suggested minimum line width (pen size) and letter height (template size) to be used when preparing a drawing that is to be microfilmed at various reduction ratios.

Reduction Ratio	4 ×	5 ×	6 ×	7 ×	8 ×	9 ×	10 ×	12 ×	16 ×	20 ×	24 ×	30 ×	36 ×
Min. Pen Size (mm.)	0.13	0.13	0.13	0.13	0.18	0.18	0.18	0.25	0.35	0.50	0.50	0.70	0.70
Min. Template Size (mm.)	1.3	1.3	1.3	1.3	1.8	1.8	1.8	2.5	3.5	5.0	5.0	7.0	7.0

Produces uniformly proportioned characters throughout the entire Metric Standard letter size range by maintaining a constant ratio of letter height to line width.

Letters and line width shown actual size

LEROY

letter height 20.0 mm/line width 2.0 mm

LEROY M

letter height 14.0 mm/line width 1.4 mm

LEROY METR

letter height 10.0 mm/line width 1.0 mm

LEROY METRIC STA

letter height 7.0 mm/line width 0.7 mm

LEROY METRIC STANDARD

letter height 5.0 mm/line width 0.5 mm

LEROY METRIC STANDARD LETTERING

letter height 3.5 mm/line width 0.35 mm

LEROY METRIC STANDARD LETTERING SET LEROY M

letter height 2.5 mm/line width 0.25 mm

LEROY METRIC STANDARD LETTERING SET LEROY METRIC STANDARD L

letter height 1.8 mm/line width 0.18 mm

LEROY METRIC STANDARD LETTERING SET LEROY METRIC STANDARD LETTERING SET LEROY MET

letter height 1.3 mm/line width 0.13 mm

LEROY® Professional Pens-Metric

LEROY Professional Pens-Metric have the same style and features of LEROY Professional Pens except that the points are in metric line widths correlated to the five standard American Drawing sizes.

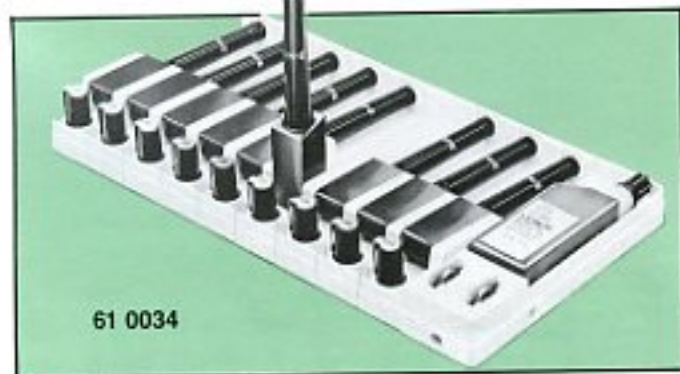

61 0034

61 0034 LEROY 9-Pen Dry Seal Selector Set, Stainless Tips — Contains 9 Professional Pens with stainless tips in metric point sizes: 0.13mm, 0.18mm, 0.25mm, 0.35mm, 0.50mm, 0.70mm, 1.00mm, 1.40mm and 2.00mm; dry seal pen caps; 9 modular Dry Seal Selector tilt holder units; 1 modular ink pack unit with ¾ oz. bottle LEROY ink, 2 nib keys, board clamp; clear plastic cover. Double dry seal feature in both Dry Seal Selector tilt holder and pocket-clip pen cap to assure quick starts whether pen is stored in DSS holder or pocket.

61 0042 LEROY 9-Pen Dry Seal Selector Set, Jewel Tips — Same as 61 0034 but with jewel tips for outstanding wear resistance and exceptionally smooth drafting. Will outlast stainless tips many times over.

61 0032 LEROY 4-Pen Dry Seal Selector Set, Stainless Tips — Contains 4 Professional Pens with stainless tips in metric point sizes: 0.25mm, 0.35mm, 0.50mm and 0.70mm; dry seal pen caps; 4 modular Dry Seal Selector tilt holder units; 1 modular ink pack unit with ¾ oz. bottle LEROY ink, 2 nib keys, board clamp; clear plastic cover.

61 0040 LEROY 4-Pen Dry Seal Selector Set, Jewel Tips — Same as 61 0032 but with jewel tips.



61 0035

61 0035 LEROY 9-Pen Set in Basic Selector Tray, Stainless Tips — Contains 9 Professional Pens with stainless tips in metric point sizes: 0.13mm, 0.18mm, 0.25mm, 0.35mm, 0.50mm, 0.70mm, 1.00mm, 1.40mm and 2.00mm; dry seal pen caps; ¾ oz. bottle LEROY ink; 1 nib key; basic selector tray with provision to hold 7 pens in upright position during use.

61 0043 LEROY 9-Pen Set in Basic Selector Tray, Jewel Tips — Same as 61 0035 but with jewel tips.

61 0033 LEROY 4-Pen Set in Basic Selector Tray, Stainless Tips — Same as 61 0035 but with 4 pens, dry seal pen caps, ¾ oz. bottle LEROY ink and 1 nib key. Pen sizes: 0.25mm, 0.35mm, 0.50mm, 0.70mm.

61 0041 LEROY 4-Pen Set in Basic Selector Tray, Jewel Tips — Same as 61 0033 but with jewel tips.

Modular concept provides "add-on" flexibility to suit your exact needs

Individual Metric Pens

***61 0022 LEROY Professional Pen, Stainless Tip, DSS** — Cap, nib key and Dry Seal Selector Module. Available in 9 metric point sizes: 0.13mm, 0.18mm, 0.25mm, 0.35mm, 0.50mm, 0.70mm, 1.00mm, 1.40mm and 2.00mm.

***61 0025 LEROY Professional Pen, Jewel Tip, DSS** — Same as 61 0022 but with jewel tip.

***61 0023 LEROY Professional Pen only, Stainless Tip** — With cap and nib key. Available in 9 metric point sizes: 0.13mm, 0.18mm, 0.25mm, 0.35mm, 0.50mm, 0.70mm, 1.00mm, 1.40mm and 2.00mm.

***61 0026 LEROY Professional Pen only, Jewel Tip** — Same as 61 0023 but with jewel tip.

Metric Replacement Points

***61 0024 Stainless Steel Replacement Points** — Available in nine sizes: 0.13mm, 0.18mm, 0.25mm, 0.35mm, 0.50mm, 0.70mm, 1.00mm, 1.40mm, 2.00mm. These points will also fit all LEROY reservoir pens.

***61 0027 Jewel Tip Replacement Points** — Same as 61 0024 but jewel tip.

***61 0030 Tungsten Carbide Replacement Points** — Same as 61 0024 but with tungsten carbide tip.

61 0031 LEROY Pen Holder only — Adapts LEROY reservoir pens 61 0051 and 61 0053 for use in Dry Seal Selector unit.

LEROY Professional Pen for new Metric Drafting System. Based on International Standard ISO 3098/1 for technical drawings and lettering, brings true standardization to the industry.

Here's how it works. LEROY Professional pens are available in nine metric point sizes: 0.13mm, 0.18mm, 0.25mm, 0.35mm, 0.50mm, 0.70mm, 1.00mm, 1.40mm and 2.00mm. These point sizes are in a geometric ratio of 1.414 ($\sqrt{2}$) between progressive line widths, thus forming a direct correlation with the ratios of the 5 standard American drawing sizes. In addition, the line width ratios of LEROY metric points correlate directly to the reproduced line widths in microfilm reductions and blowbacks.

For example, if an original drawing is reduced on microfilm and subsequently blown back to half size, revisions could be made directly on the blowback with the LEROY metric point two sizes smaller. Similarly, if the blowback is one size smaller, the revisions would be made with the LEROY metric point one size smaller than that used on the original.

Metric line width chart

pen no.	ISO color codes	metric point size	Inch equivalent
		0.13 mm	
		0.18 mm	
		0.25 mm	
		0.35 mm	
		0.50 mm	
		0.70 mm	
		1.00 mm	
		1.40 mm	
		2.00 mm	
13	violet	0.13 mm	.0051"
18	red	0.18 mm	.0071"
25	white	0.25 mm	.0098"
35	yellow	0.35 mm	.0138"
50	brown	0.50 mm	.0197"
70	blue	0.70 mm	.0276"
100	orange	1.00 mm	.0394"
140	green	1.40 mm	.0551"
200	light grey	2.00 mm	.0787"

Line widths in accordance with International Standard ISO 3098/1 for technical drawings and lettering
*Specify Size

LEROY® Accessories

LETTERING/DRAWING INKS



58 0005 LEROY Black Waterproof Lettering Ink—In pen filler cartridge. This ink is manufactured for K&E by the makers of Pelikan Ink to a special formula for use with LEROY Pens. The cartridge is particularly convenient for filling the pens easily and cleanly.

58 0006 LEROY Black Waterproof Drawing Ink—Opaque black ink for vellum and film. In handy 3/4 fl. oz. plastic pen filler bottle.

58 0007 LEROY Black Waterproof Drawing Ink—Super black ink recommended for use on HERCULENE® Drafting Film and other polyester drafting films. In 3/4 fl. oz. plastic pen filler bottle.

58 0008 LEROY Black Waterproof Drawing Ink—Opaque black ink for use on vellum. In 3/4 fl. oz. plastic pen filler bottle.

PEN CLEANERS



61 3115 LEROY Cleaning Kit—A convenient way to clean LEROY Pens. Consists of 2 oz. bottle of LEROY Cleaning Fluid 61 3117 with plastic sieve for soaking pens. Water bottle with sieve for washing pens, and rubber bulb for drying insides of pens after washing. In handy container for desk drawer.



61 3126 LEROY Ultrasonic Cleaner—A compact sized unit that quickly and efficiently cleans LEROY Pens and all types of artist and draftsman pens. Just immerse the tip of the pen into the cleaner to start ink flow. If pen is dried up and clogged from long disuse, the 80,000 cycle per second action will free the parts so that the pen can be disassembled without damage. LEROY Pen Cleaning Fluid 61 3117 is recommended.

SPECIFICATIONS

Cleaning cup dimensions: 2 1/2" diameter, 1 1/2" deep. Unit dimensions: 4 1/2" x 3 1/4" x 3 3/8". Solid-state circuitry. Operates on 110-120 VAC, 3-wire grounded cord, 1-amp replaceable fuse, with automatic frequency and load control (approx. 80KHZ).

61 3127 Ultrasonic Cleaner—Same as 61 3126 except operates on 210-220 VAC.



61 3131 Pressure Pen Cleaner/Plotter Point Starter—An effective economical way to clean drawing points of LEROY Reservoir Pens, COMSTOC® Plotter Points and most other brands of technical pens.

Operation is simple and only light squeeze pressure is required. Cleaning fluid is drawn up through the line tube and air channel of the point and flushed back through the point. A plastic adapter and threaded connector is provided that enables unit to be used as an ink flow started. Furnished with instructions.

LEROY CLEANING FLUID

Recommended for cleaning LEROY Pens, fountain pens and all other writing instruments.

61 3117 Cleaning Fluid—2 fl. oz. bottle.

61 3120 Cleaning Fluid—1 quart bottle.

61 3123 Plastic Sieve—Fits No. 61 3117 bottle and tank of Ultrasonic Cleaner No. 61 3126. Conveniently holds small pen parts and points.

LEROY® Accessories

LEROY 0.5mm PENCIL



61 0200 LEROY Mechanical Pencil, for 0.5mm Lead—For uniform pencil lettering without the need to stop and repoint. Draws a 0.5mm line that never varies in width. This top loading mechanical pencil has automatic pushbutton feed. Fits all LEROY Scribes and is also ideal for professional drafting and general writing.

Pencil is of all metal construction with brushed chrome finish. An eraser and cleaner wire is under the push-button top. Furnished with tube of 1 doz. 0.5mm (.020") HB leads.

61 0201 LEROY Leads, 0.5mm—2¾ in. long, ultra-fine 0.5mm (.020") diameter, HB degree, tube of 12. For 61 0200 Pencil.

61 0205 LEROY "020" Refill Leads — ¾ in. long, .020 in. diameter, tube of 24. For discontinued model 61 0198 "020" Pencil.

LEAD CLUTCH



61 0210 Lead Clutch — For pencil lettering work with any LEROY Scriber. Holds regular draftsman's leads from .070 in. to .090 in. diameter. This efficient clutch grips the lead firmly so that it will not slip back with pressure on drawing surface. Leads can be pointed in the No. 58 0500 VARI-POINT Lead Pointer or the No. 58 0515 TRU-POINT Lead Pointer without removal from the clutch.

61 3015 Leads — 2 in. long, 6 in tube, for Lead Clutch No. 61 0210.

LEAD POINTER

58 0515 Tru-Point "Quick Change" Variable Taper Lead Pointer, Model D—This pointer, for sharpening leads in Draftsman's Mechanical Pencils to points with variable tapers, also sharpens LEROY® leads to perfectly centered points of correct length and taper without the need of removing them from LEROY Lead Clutch 61 0210. A special bushing is furnished with the Pointer for shaping LEROY leads.

Weights 23 oz.; has non-skid base which holds firmly on table. Replaceable "Quick Change" Model D abrasive cup will ordinarily last three or four months.

58 0516 Tru-Point "Quick Change" Abrasive Cups, Model D—Regular grit, for Model D 58 0515; box of three.

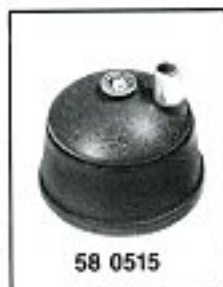

58 0515

LEAD CLEANERS



58 0524 CLEAN-POINT Pencil Lead Cleaner — For cleaning loose dust particles off mechanical pencil lead points after sharpening. Lead is simply inserted into polyfoam ring and withdrawn for quick, easy removal of particles. The ring is designed to fit around TRU-POINT and VARI-POINT® lead pointers. Box of three rings.

58 0525 CLEAN-POINT JR. Pencil Lead Cleaner — Similar to 58 0524 but is disc-shaped and has pressure-sensitive adhesive back for attaching to any surface. This feature makes it especially good for use on drafting boards and in schools. Dispenser box of ten discs.

STRAIGHTEDGE



61 3105 LEROY Line-spacing Straightedge — Luxylite, 15 in. long, 1¾ in. wide. Shows immediately where to place LEROY template to give first line of lettering exactly where it is required. Used with any LEROY template up to size 500, it readily determines spacing between lines best proportioned to height of lettering.

LETTER SIZE ADAPTER



61 3100 Letter Size Adapter — For extending or condensing LEROY Lettering. With the adapter, used with Scribes Nos. 61 0004, or 61 0006, the height of letters or numerals drawn with any LEROY template can be increased or decreased by amounts up to one third of their normal height. The width of letters and numerals is not changed.

HEIGHT HEIGHT HEIGHT

All three examples above were lettered from the same template (size 175C). In the center is standard lettering (without the adapter). To right and left are examples of maximum variations in height that the adapter gives.

CASE WITHOUT CONTENTS



61 2947 LEROY Case—Same as furnished with LEROY Lettering Sets but without contents. Made of high-impact molded plastic, in two tone green.

COMPASS with Reservoir Pen Adapter



These large Bow Compasses, with LEROY Reservoir Pen Adapter and Bent Needle, are designed to draw accurate circles as small as .040" (1mm). Will accept LEROY Reservoir Pens 61 0051, 61 0053, and LEROY Technical Pens 61 0023 and 61 0026. (Pen is not included with compass.)

55 1723 Mark I Large Bow Compass—6½", hard brass, highly polished and chrome-plated; knee joints in both legs. With pen adapter, bent needle, interchangeable pencil insert, and lead box.

55 2873 APOLLO® Large Bow Compass—6½", hard brass, matte-chrome finish; insert leg with knee joint. With pen adapter, bent needle, interchangeable pencil insert, and lead box.



Compass Adapter for LEROY Pens

55 3280 Compass Adapter for LEROY Pens—Enables draftsman to use LEROY Reservoir or Standard Lettering pens with a drawing compass or bow pencil to obtain precise-width ink lines. Adapter shaft fits into lead holder of compass and is adjustable so that pen may be set perpendicular to the drawing surface regardless of the bow opening.

Also ideal for use with LEROY 0.5mm Pencil No. 61 0200 for uniform, fine line pencil work.

SLIDECOMP® Compass

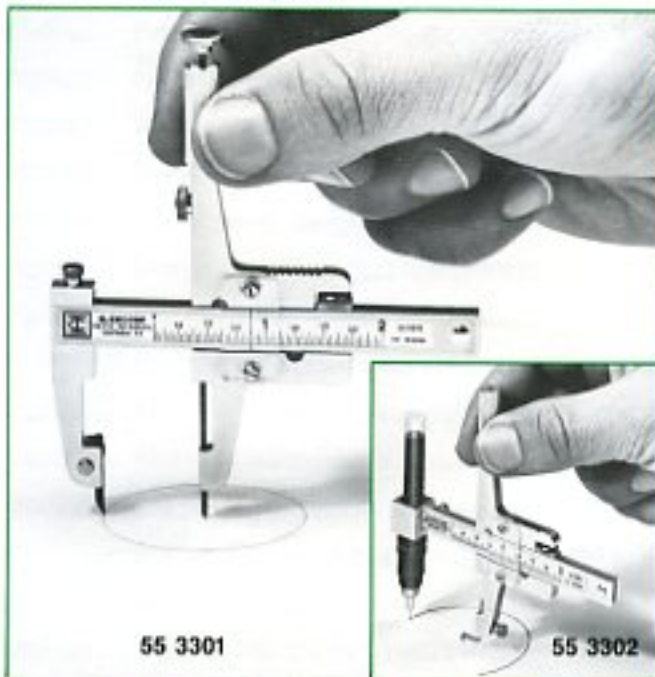

55 3301 SLIDECOMP Compass—A direct reading compass with two scales—graduated to 32nds of an inch on one side and millimeters on the other. This precision instrument is engineered to give repeat positioning accuracy of $\pm .005$ per inch. Setting the compass is accomplished simply by sliding the scale and lining up the desired circle size with the hairline indicator. Its minimum radius setting is .040 inches (1 millimeter) and its maximum radius setting is 2 inches (50 millimeters).

The SLIDECOMP compass can quickly convert to a drop compass. It may also be made into a precision divider by replacing the lead with a 2 millimeter diameter needle. The needle is included with the compass.

55 3302 SLIDECOMP Compass Conversion Kit—Converts the SLIDECOMP compass to an inking compass. Standard bar is easily replaced with a bar that is designed to hold a reservoir pen. Kit includes bar and a bent needle point to compensate for the center point change.

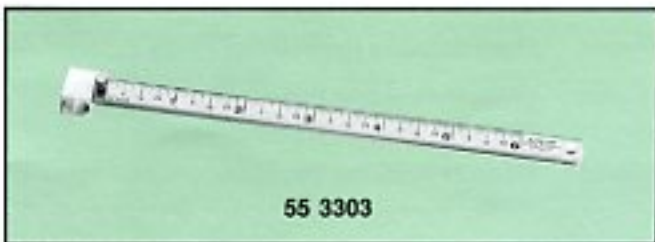

55 3303 6" Trammel Bar—A six inch trammel bar converts the SLIDECOMP Compass into a direct reading beam type compass that can make circles with a radius of 6 inches. The trammel bar holds a LEROY reservoir pen. The direct reading scale is divided into 32nds of an inch.

Numerical Index

Product No.	Description	Page No.	Product No.	Description	Page No.
ACCESSORIES					
55 1723	Mark 1 Large Bow Compass	37	61 0031	Pen Holder Only	34
55 2873	APOLLO® Large Bow Compass	37	61 0032	Metric 4-Pen DSS Set, Stainless Tips	34
55 3280	Compass Adapter	37	61 0033	Metric 4-Pen Set, Basic Tray, Stainless Tips	34
55 3301	SLIDECOMP Compass	37	61 0034	Metric 9-Pen DSS Set, Stainless Tips	34
55 3302	SLIDECOMP Conversion Kit	37	61 0035	Metric 9-Pen Set, Basic Tray, Stainless Tips	34
55 3303	SLIDECOMP Trammel Bar	37	61 0040	Metric 4-Pen DSS Set, Jewel Tips	34
58 0005	Black Waterproof Ink, Cartridge	35	61 0041	Metric 4-Pen Set, Basic Tray, Jewel Tips	34
58 0006	Black Waterproof Ink, ¾ oz.	35	61 0042	Metric 9-Pen DSS Set, Jewel Tips	34
58 0007	Super Black Waterproof Ink, ¾ oz.	35	61 0043	Metric 9-Pen Set, Basic Tray, Jewel Tips	34
58 0008	Opaque Black Waterproof Ink, ¾ oz.	35	61 0045	Ink Pack for DSS unit	31
58 0515	TRU-POINT Lead Pointer	36	61 0046	Dry Seal Selector for 1 Pen	31
58 0516	TRU-POINT Abrasive Cups	36	61 0048	Dry Seal Selector for 4 Pens	31
58 0524	CLEAN-POINT Pencil Lead Cleaner	36	61 0049	Dry Seal Selector for 9 Pens	31
58 0525	CLEAN-POINT JR. Pencil Lead Cleaner	36	61 0051	Stainless Steel Reservoir Pens	28
SCRIBERS					
61 0003	New Style Adjustable Scriber	7	61 0052	Stainless Steel Replacement Points	28
61 0004	Adjustable Scriber	7	61 0053	Jewel Tip Reservoir Pens	28
61 0015	Adjustable Scriber, Large	7	61 0054	Jewel Tip Replacement Points	28
61 0020	Height & Slant Control Scriber	7	61 0055	Holder for Reservoir Pens	28
PENS AND PEN SETS					
61 0022	Metric Professional Pen, Stainless Tip, DSS	34	61 0062	Stainless Steel Reservoir Pen Set, 7 Pens ..	28
61 0023	Metric Professional Pen Only, Stainless Tip	34	61 0063	Jewel Tip Reservoir Pen Set, 7 Pens	28
61 0024	Metric Stainless Replacement Points	34	61 0064	Stainless Steel Reservoir Pen Set, 8 Pens ..	28
61 0025	Metric Professional Pen, Jewel Tip, DSS	34	61 0070	Standard Lettering Pens	29
61 0026	Metric Professional Pen Only, Jewel Tip	34	61 0100	Standard Cleaning Pins	29
61 0027	Metric Jewel Tip Replacement Points	34	61 0130	Long Point Lettering Pens	29
61 0030	Metric Tungsten Carbide Replacement Points	34	61 0160	Long Point Cleaning Pins	29
			61 0162	Stainless Steel Replacement Points, Professional	31
			61 0163	Jewel Tip Replacement Points, Professional	31
			61 0164	Tungsten Carbide Tip Replacement Points, Professional	31

Product No.	Description	Page No.	Product No.	Description	Page No.
61 0165	Standard Professional Pen, Stainless Tip, DSS	31	61 0650	Extended Gothic, C	14
61 0166	Standard Professional Pen, Stainless Tip	31	61 0660	News Gothic, C	14
61 0167	Standard Professional Pen, Jewel Tip, DSS	31	61 0670	News Gothic Condensed, C	14
61 0168	Standard Professional Pen, Jewel Tip	31	61 0680	News Gothic Bold, C	14
61 0169	9-Pen DSS Set, Stainless Tips	30	61 0700	Outline Gothic, C	15
61 0170	4-Pen DSS Set, Stainless Tips	30	61 0720	Nitsche Bold, PC	15
61 0171	9-Pen DSS Set, Jewel Tips	30	61 0750	Franklin Gothic, PC	15
61 0172	4-Pen DSS Set, Jewel Tips	30	61 0900	Franklin Gothic, PL	15
61 0173	9-Pen Set, Basic Tray, Stainless Tips	31	61 0850	Alternate Gothic, PC	16
61 0174	7-Pen Set, Basic Tray, Stainless Tips	31	61 0900	Alternate Gothic, PL	16
61 0175	4-Pen Set, Basic Tray, Stainless Tips	31	61 0950	Spartan Medium, PC	16
61 0176	9-Pen Set, Basic Tray, Jewel Tips	31	61 1000	Spartan Black, PC	16
61 0177	7-Pen Set, Basic Tray, Jewel Tips	31	61 1050	Spartan Black, PL	16
61 0178	4-Pen Set, Basic Tray, Jewel Tips	31	61 1100	Spartan Extra Black, PC	17
61 0191	Standard Pen Set in Caddy	29	61 1150	Stymie Medium, PC	17
61 0192	Pen Caddy for Standard Pens	29	61 1200	Stymie Medium, PL	17
61 0200	Mechanical Pencil; 0.5mm Leads	36	61 1250	Cartographic, PC	17
61 0201	0.5mm Refill Leads, HB	36	61 1300	Cartographic, PL	17
61 0205	"020" Refill Leads for 61 0200	36	61 1350	Bernhardt Modern Bold, PC	18
61 0210	Lead Clutch	36	61 1400	Bernhardt Modern Bold, PL	18
TEMPLATES			61 1450	Caslon Bold Condensed, PC	18
61 0260	Metric Standard	12, 33	61 1500	Caslon Bold Condensed, PL	18
61 0300	Standard CL	12	61 1550	Old English, PC	18
61 0350	Standard, C	12	61 1600	Old English, PL	18
61 0400	Standard, L	12	61 1650	Script, PCL	19
61 0450	Modern, C	13	61 1700	Informal Style, PC	19
61 0500	Modern, CL	13	61 1750	Freehand, PC	19
61 0550	Reversed Gothic, C	13	61 1800	Freehand, PL	19
61 0600	Condensed Gothic, C	13	61 1850	Shadow, C	19
61 0602	Condensed Gothic, L	13	61 1900	Outline Shadow, PC	20
			61 1950	Instrument Dial	20
			61 1960	Europa, CN	20
			61 1965	Europa, CLN	20

Numerical Index

Product No.	Description	Page No.	Product No.	Description	Page No.
61 1970	Europa, L	20	61 2944	Basic Starter Set	6
61 2000	Greek, CL	20			
61 1980	Microfont, CN & Symbols	21		ACCESSORIES	
61 1985	Microfont, CN	21	61 2947	Empty Case	37
61 1990	Microfont, Symbols	21	61 3010	Double Ended Tracer Pin	7
61 2050	Russian, PC	21	61 3015	Leads, for No. 61 0210	36
61 2100	Hebrew, C	21	61 3035	Socket Holder for Pens 0000 to 8	29
61 2150	Isometric, CN	21	61 3075	Standard Penholder for Pens 0000 to 8	29
61 2200	Isometric, Circles	21	61 3080	Standard Penholder for Pens 9 to 14	29
61 2250	Map Symbols	22	61 3100	Letter Size Adapter	36
61 2300	Military Map Symbols	22	61 3105	Line-Spacing Straightedge	36
61 2350	Geological Symbols	22	61 3115	Pen Cleaning Kit	35
61 2400	North Pointers	23	61 3117	Cleaning Fluid, 2 oz.	35
61 2450	Electrical Symbols	24	61 3120	Cleaning Fluid, 1 qt.	35
61 2501	Electronic Tube Symbols	24	61 3123	Plastic Sieve	35
61 2600	Fraction	25	61 3126	Ultrasonic Cleaner 115V	35
61 2650	Mathematical Symbols	25	61 3127	Ultrasonic Cleaner 220V	35
61 2700	Music Symbols	25	61 3131	Pressure Pen Cleaner/Point Starter	35
61 2702	Musicopy Symbols	26			
61 2704	Slur-Tie Symbols	26			
61 2750	Graph Symbols	27			
61 2800	"Your Own Design", Wording	27			
61 2850	"Your Own Design", Symbols	27			
	SETS				
61 2880	Metric, 9 Templates	6, 32			
61 2890	Metric, 4 Templates	6, 32			
61 2901	Standard, 11 Templates	5			
61 2906	Standard, 8 Templates	5			
61 2911	Standard, 5 Templates	5			
61 2916	Standard, 6 Templates	5			
61 2921	Standard, 3 Templates	5			
61 2942	Microfont	6			



LEROY® is the trademark of KEUFFEL & ESSER COMPANY, the only makers of LEROY Lettering and Symbol Drawing Equipment, and is registered in the U.S. Patent and Trademark Office.

creative
products
for the
creative
engineer



KEUFFEL & ESSER COMPANY

